One-piece tray

Selection guide



Ventilated trough

- Formed from a pre-punched sheet to produce a one-piece ventilated trough
- Available in aluminum, pregalvanized steel, hot-dipped galvanized steel and stainless steel 316
- Fittings are also available to complete this cable tray system

Solid trough

- Fabricated from one sheet to form a continuous one-piece tray design
- Available in aluminum, pregalvanized steel, hot-dipped galvanized steel and stainless steel 316
- Fittings are also available to complete this cable tray system

One-piece tray

Selection guide

Straight section number selection

How to create part numbers

ABB has created a numbering system based on the order of selection criteria. For example, the first selection issue is the environment to which the cable tray will be subjected. This selection will lead to the best material for your application. For complete details on the cable tray selection process, see page A8.

Methods

1. Select the material best suited to your environment. Refer to technical section page A8.
2. Determine the tray series using the NEMA load/span designations page A14, and sizing cable tray page A21.
3. Select nominal depth and width of tray based on cable loading. See sizing cable tray page A21.
4. Select the bottom type based on cables and spacing requirements.
5. The last number is the length of the cable tray.

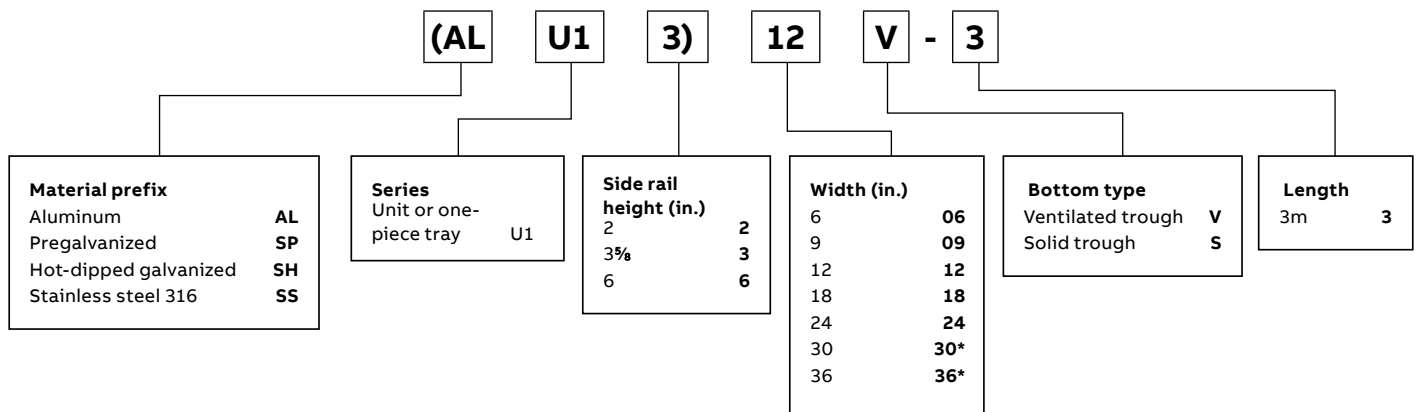

*Welded flat rung

Standard straight length is 10 feet nominal
3m = 9.842 ft.

One-piece tray straight lengths

2 in. straight sections/AL, SP, SH, SS – Solid and vented



Technical specifications

All calculations and data are based on 36 in. wide cable trays with rungs spaced on 12 in. centers with tray supported as simple spans with deflection measured at the midpoint. Continuous spans may reduce deflection by as much as 50%.

Deflection factor: For lighter loads, deflection at any length can be calculated by multiplying the load by the deflection factor.

2 in. straight sections/AL, SP, SH, SS – Solid and vented

Series		Support span (feet)		
		6	8	10
ALU12	Load (lb/ft.)	69	39	25
	Deflection (in.)	0.382	0.730	1.000
	Deflection factor	0.006	0.019	0.040
SPU12 SHU12	Load (lb/ft.)	69	39	25
	Deflection (in.)	0.382	0.730	1.000
	Deflection factor	0.006	0.019	0.040
SSU12	Load (lb/ft.)	69	39	25
	Deflection (in.)	0.382	0.730	1.000
	Deflection factor	0.006	0.019	0.040

Straight section number selection

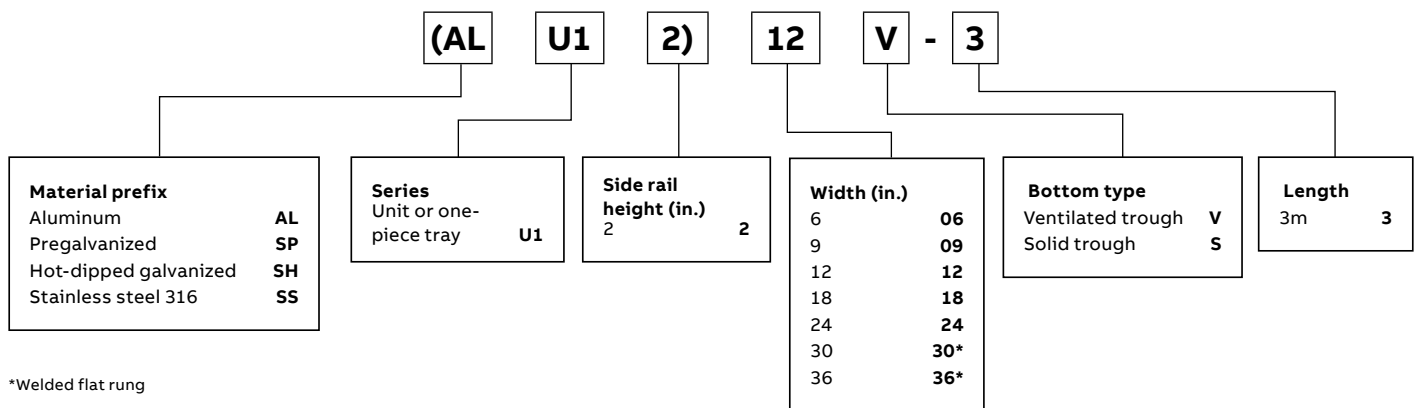

*Welded flat rung

Standard straight length is 10 feet nominal.
3 m = 9.842 ft.

For fittings, consult pages A182 to A200.

Dimensions

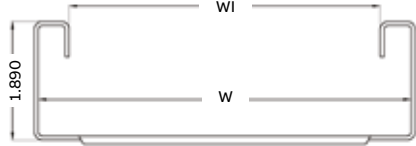

All U12 series (dimensions)

	W (in.)	Wi (in.)
	6	5.0
	9	8.0
	12	11.0
	18	17.0
	24	23.0
	30	29.0
	36	35.0

Technical specifications

Load ratings: 1.5 safety factor. All tray sections will support an additional 200 lb concentrated load on any portion of tray above and beyond published load class.

Load ratings: 1.5 safety factor

Series	Dimensions	Classifications	
		NEMA	CSA
ALU12	See above	-	A
SPU12	See above	-	A
SHU12	See above	-	A
SSU12	See above	-	A

One-piece tray straight lengths

3⁵/₈ in. straight sections/AL, SP, SH, SS – Solid and vented

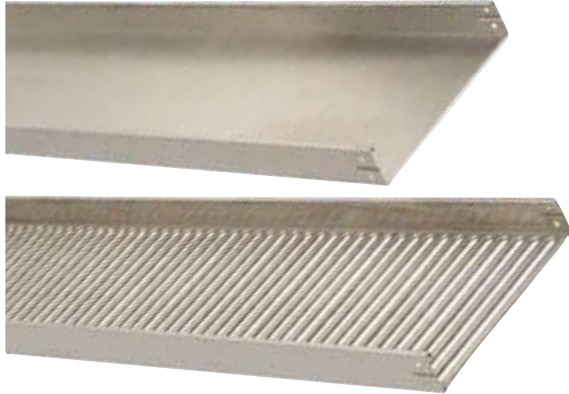

Technical specifications

All calculations and data are based on 36 in. wide cable trays with tray supported as simple spans with deflection measured at the midpoint. Continuous spans may reduce deflection by as much as 50%.

Deflection factor: For lighter loads, deflection at any length can be calculated by multiplying the load by the deflection factor.

3⁵/₈ straight sections/AL, SP, SH, SS – Solid and vented

Series		Support span (feet)		
		6	8	10
ALU13	Load (lb/ft.)	180	101	65
	Deflection (in.)	0.382	0.430	0.540
	Deflection factor	0.002	0.004	0.008
SPU13 SHU13	Load (lb/ft.)	180	101	65
	Deflection (in.)	0.125	0.250	0.320
	Deflection factor	0.001	0.002	0.005
SSU13	Load (lb/ft.)	180	101	65
	Deflection (in.)	0.125	0.250	0.320
	Deflection factor	0.001	0.002	0.005

Straight section number selection

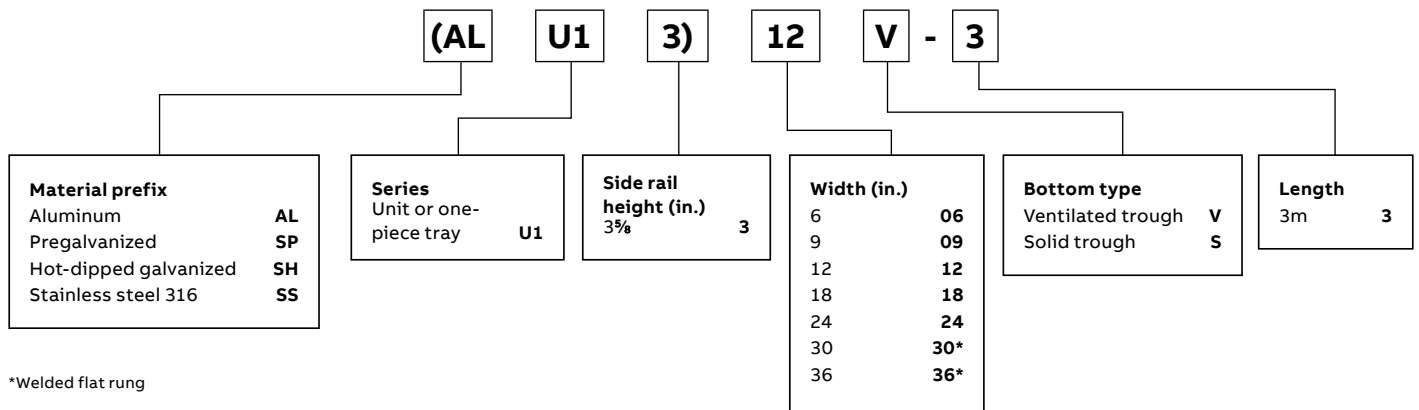

*Welded flat rung

Standard straight length is 10 feet nominal.
3 m = 9.842 ft.

For fittings, consult pages A182 to A200.

Dimensions

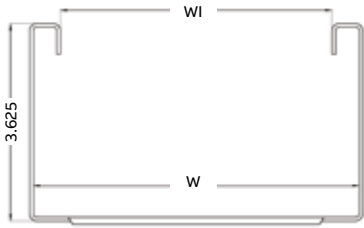

All U13 series (dimensions)	
W (in.)	Wi (in.)
6	5.0
9	8.0
12	11.0
18	17.0
24	23.0
30	29.0
36	35.0

Technical specifications

Load ratings: 1.5 safety factor. All tray sections will support an additional 200 lb concentrated load on any portion of tray above and beyond published load class.

Load ratings: 1.5 safety factor

Series	Dimensions	Classifications	
		NEMA	CSA
ALU13	See above	8C	C
SPU13	See above	8C	C
SHU13	See above	8C	C
SSU13	See above	8C	C

One-piece tray straight lengths

6 in. straight sections/AL, SP, SH, SS – Solid and vented

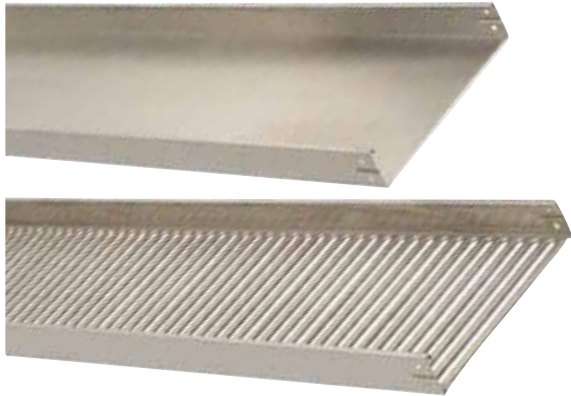

Technical specifications

All calculations and data are based on 36 in. wide cable trays with tray supported as simple spans with deflection measured at the midpoint. Continuous spans may reduce deflection by as much as 50%.

Deflection factor: For lighter loads, deflection at any length can be calculated by multiplying the load by the deflection factor.

6 in. straight sections/AL, SP, SH, SS – Solid and vented

Series		Support span (feet)		
		6	8	10
ALU16	Load (lb/ft.)	180	101	65
	Deflection (in.)	0.082	0.128	0.160
	Deflection Factor	0.000	0.001	0.008
SPU16 SHU16	Load (lb/ft.)	180	101	65
	Deflection (in.)	0.125	0.250	0.320
	Deflection Factor	0.001	0.002	0.005
SSU16	Load (lb/ft.)	180	101	65
	Deflection (in.)	0.125	0.250	0.320
	Deflection Factor	0.001	0.002	0.005

Straight section number selection

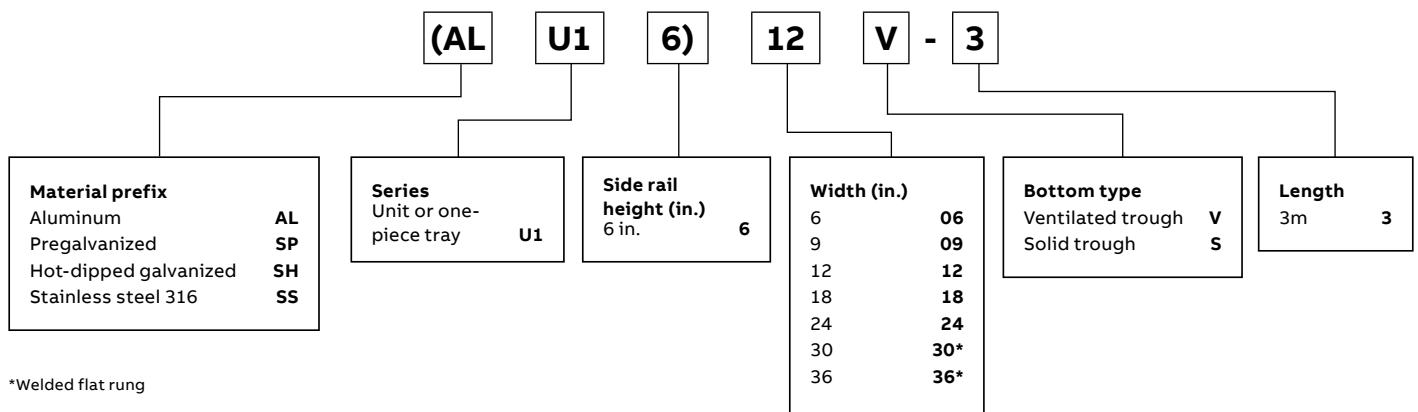

Standard straight length is 10 feet nominal.
3 m = 9.842 ft.

For fittings, consult pages A182 to A200.

Dimensions

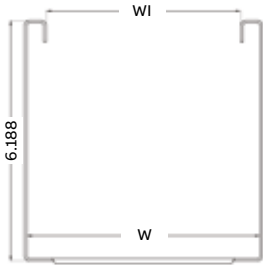

All U16 series (dimensions)	
W (in.)	Wl (in.)
6	5.0
9	8.0
12	11.0
18	17.0
24	23.0
30	29.0
36	35.0

Technical specifications

Load ratings: 1.5 safety factor. All tray sections will support an additional 200 lb concentrated load on any portion of tray above and beyond published load class.

Load ratings: 1.5 safety factor

Series	Dimensions	Classifications	
		NEMA	CSA
ALU16	See above	8C	C
SPU16	See above	8C	C
SHU16	See above	8C	C
SSU16	See above	8C	C

One-piece tray

Fittings



Fittings number selection

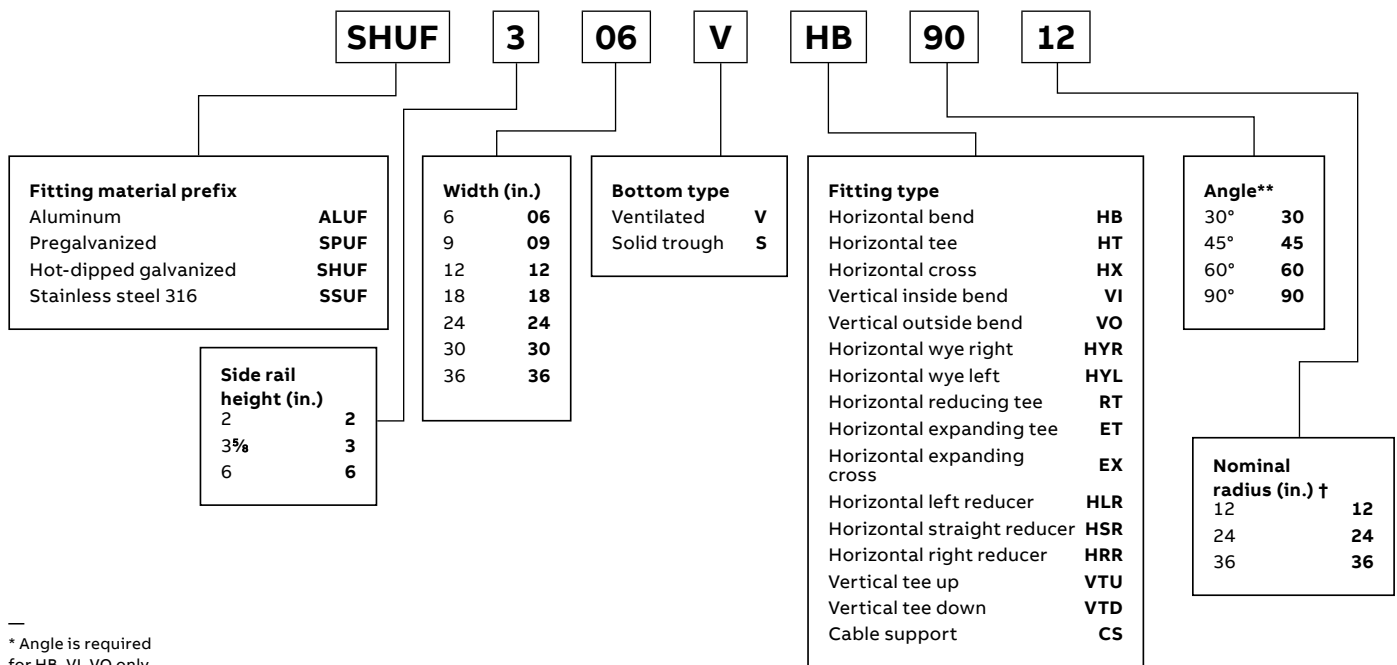

* Angle is required for HB, VI, VO only.

† Radius is not required for the following fitting types: HYR, HYL, HLR, HRR, HSR

One-piece tray

90° Horizontal bend fittings

90° Horizontal bend

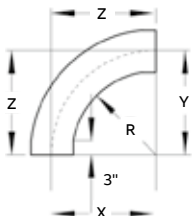

	Nominal radius (in.)	Nominal width (in.)	Cat. no.	Dimensions (in.)		
				X	Y	Z
	12	06	Prefix(t)-06-(*)-HB90-12	15	15	15
	12	09	Prefix(t)-09-(*)-HB90-12	16½	16½	16½
	12	12	Prefix(t)-12-(*)-HB90-12	18	18	18
	12	18	Prefix(t)-18-(*)-HB90-12	21	21	21
	12	24	Prefix(t)-24-(*)-HB90-12	24	24	24
	12	30	Prefix(t)-30-(*)-HB90-12	27	27	27
	12	36	Prefix(t)-36-(*)-HB90-12	30	30	30
	24	06	Prefix(t)-06-(*)-HB90-24	27	27	17
	24	09	Prefix(t)-09-(*)-HB90-24	28½	28½	28 ½
	24	12	Prefix(t)-12-(*)-HB90-24	30	30	30
	24	18	Prefix(t)-18-(*)-HB90-24	33	33	33
	24	24	Prefix(t)-24-(*)-HB90-24	36	36	36
	24	30	Prefix(t)-30-(*)-HB90-24	39	39	39
	24	36	Prefix(t)-36-(*)-HB90-24	42	42	42
	36	06	Prefix(t)-06-(*)-HB90-36	39	39	39
	36	09	Prefix(t)-09-(*)-HB90-36	40½	40½	40½
	36	12	Prefix(t)-12-(*)-HB90-36	42	42	42
	36	18	Prefix(t)-18-(*)-HB90-36	45	45	45
	36	24	Prefix(t)-24-(*)-HB90-36	48	48	48
	36	30	Prefix(t)-30-(*)-HB90-36	51	51	51
	36	36	Prefix(t)-36-(*)-HB90-36	54	54	54

(t) Insert side rail height. (*) Insert bottom style to complete cat. no. Includes 1 pair of splice plates with hardware.

Selection guide

- Prefix: ALUF (aluminum), SPUF (pregalv.), SHUF (hot-dip galv.), SSUF (stainless steel)
- Inside tray widths: 06, 09, 12, 18, 24, 30, 36 in.
- Angle: 90°
- Nominal radius: 12, 24, 36 in.
- Bottom styles: V– ventilated, S– solid
- Side rail height: 2, 3, 6 in.

Part numbering system

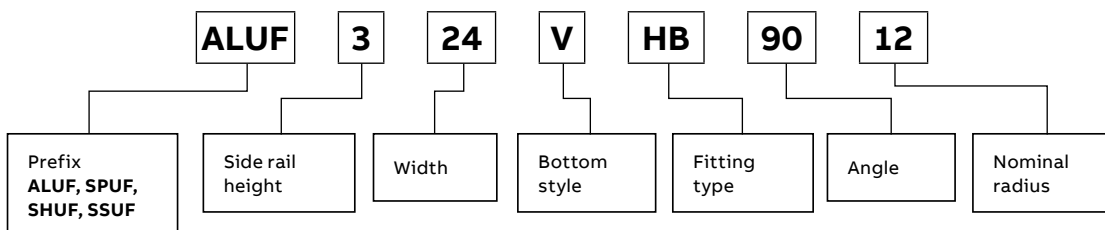

One-piece tray

60° Horizontal bend fittings

60° Horizontal bend

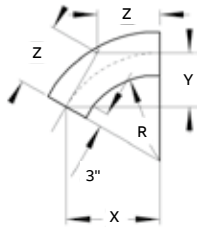

Nominal radius (in.)	Nominal width (in.)	Cat. no.	Dimensions (in.)		
			X	Y	Z
12	06	Prefix(t)-06-(*)-HB60-12	14 ⁷ / ₈	8 ⁵ / ₈	9 ¹⁵ / ₁₆
12	09	Prefix(t)-09-(*)-HB60-12	16 ³ / ₁₆	9 ³ / ₈	10 ¹³ / ₁₆
12	12	Prefix(t)-12-(*)-HB60-12	17 ¹ / ₂	10 ¹ / ₂	11 ¹¹ / ₁₆
12	18	Prefix(t)-18-(*)-HB60-12	20 ¹ / ₁₆	11 ⁵ / ₈	13 ³ / ₈
12	24	Prefix(t)-24-(*)-HB60-12	22 ¹¹ / ₁₆	13 ³ / ₈	15 ¹ / ₂
12	30	Prefix(t)-30-(*)-HB60-12	25 ⁵ / ₁₆	14 ⁵ / ₈	16 ⁷ / ₈
12	36	Prefix(t)-36-(*)-HB60-12	27 ⁷ / ₈	16 ¹ / ₂	18 ⁹ / ₁₆
24	06	Prefix(t)-06-(*)-HB60-24	25 ⁵ / ₁₆	14 ⁵ / ₈	16 ⁷ / ₈
24	09	Prefix(t)-09-(*)-HB60-24	26 ¹⁹ / ₃₂	15 ³ / ₈	17 ²³ / ₃₂
24	12	Prefix(t)-12-(*)-HB60-24	27 ⁷ / ₈	16 ¹ / ₂	18 ⁹ / ₁₆
24	18	Prefix(t)-18-(*)-HB60-24	30 ¹ / ₂	17 ⁷ / ₈	20 ⁵ / ₁₆
24	24	Prefix(t)-24-(*)-HB60-24	33 ³ / ₁₆	19 ¹ / ₂	22 ¹ / ₁₆
24	30	Prefix(t)-30-(*)-HB60-24	35 ¹¹ / ₁₆	20 ⁹ / ₈	23 ¹³ / ₁₆
24	36	Prefix(t)-36-(*)-HB60-24	38 ¹ / ₄	22 ¹ / ₂	25 ¹ / ₂
36	06	Prefix(t)-06-(*)-HB60-36	35 ¹¹ / ₁₆	20 ⁹ / ₈	23 ¹³ / ₁₆
36	09	Prefix(t)-09-(*)-HB60-36	36 ³¹ / ₃₂	21 ³ / ₈	24 ²¹ / ₃₂
36	12	Prefix(t)-12-(*)-HB60-36	38 ¹ / ₄	22 ¹ / ₂	25 ¹ / ₂
36	18	Prefix(t)-18-(*)-HB60-36	40 ⁷ / ₈	23 ³ / ₈	27 ¹ / ₄
36	24	Prefix(t)-24-(*)-HB60-36	43 ¹ / ₂	25 ⁵ / ₈	29
36	30	Prefix(t)-30-(*)-HB60-36	46 ¹ / ₁₆	26 ⁵ / ₈	30 ¹¹ / ₁₆
36	36	Prefix(t)-36-(*)-HB60-36	48 ¹¹ / ₁₆	28 ³ / ₈	32 ⁷ / ₁₆

(t) Insert side rail height. (*) Insert bottom style to complete cat. no. Includes 1 pair of splice plates with hardware.

Selection guide

- Prefix: ALUF (aluminum), SPUF (pregalv.), SHUF (hot-dip galv.), SSUF (stainless steel)
- Inside tray widths: 06, 09, 12, 18, 24, 30, 36 in.
- Angle: 60°
- Nominal radius: 12, 24, 36 in.
- Bottom styles: V– ventilated, S– solid
- Side rail height: 2, 3, 6 in.

Part numbering system

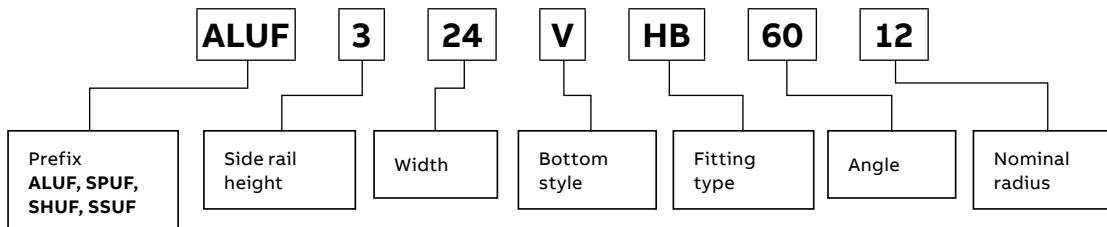

One-piece tray

45° Horizontal bend fittings

45° Horizontal bend

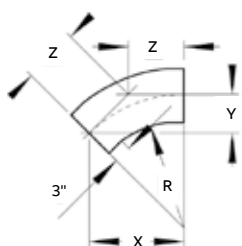

Nominal radius (in.)	Nominal width (in.)	Cat. no.	Dimensions (in.)		
			X	Y	Z
12	06	Prefix(t)-06-(*)-HB45-12	13 ⁵ / ₈	5 ⁵ / ₈	8
12	09	Prefix(t)-09-(*)-HB45-12	14 ¹¹ / ₁₆	6 ¹ / ₁₆	8 ¹⁹ / ₃₂
12	12	Prefix(t)-12-(*)-HB45-12	15 ³ / ₄	6 ¹ / ₂	9 ³ / ₁₆
12	18	Prefix(t)-18-(*)-HB45-12	17 ⁷ / ₈	7 ³ / ₈	10 ⁷ / ₁₆
12	24	Prefix(t)-24-(*)-HB45-12	20	8 ³ / ₄	11 ¹¹ / ₁₆
12	30	Prefix(t)-30-(*)-HB45-12	22 ¹ / ₁₆	9 ³ / ₈	12 ¹⁵ / ₁₆
12	36	Prefix(t)-36-(*)-HB45-12	24 ³ / ₁₆	10	14 ³ / ₁₆
24	06	Prefix(t)-06-(*)-HB45-24	22 ¹ / ₁₆	9 ³ / ₈	12 ¹⁵ / ₁₆
24	09	Prefix(t)-09-(*)-HB45-24	23 ¹ / ₈	9 ⁹ / ₁₆	13 ⁹ / ₁₆
24	12	Prefix(t)-12-(*)-HB45-24	24 ³ / ₁₆	10	14 ³ / ₁₆
24	18	Prefix(t)-18-(*)-HB45-24	26 ⁵ / ₁₆	10 ¹⁵ / ₁₆	15 ⁷ / ₁₆
24	24	Prefix(t)-24-(*)-HB45-24	28 ⁷ / ₁₆	11 ¹³ / ₁₆	16 ¹¹ / ₁₆
24	30	Prefix(t)-30-(*)-HB45-24	30 ⁹ / ₁₆	12 ¹ / ₁₆	17 ¹⁵ / ₁₆
24	36	Prefix(t)-36-(*)-HB45-24	32 ¹¹ / ₁₆	13 ⁹ / ₁₆	19 ¹ / ₈
36	06	Prefix(t)-06-(*)-HB45-36	30 ⁹ / ₁₆	12 ¹ / ₁₆	17 ¹⁵ / ₁₆
36	09	Prefix(t)-09-(*)-HB45-36	31 ⁵ / ₈	13 ³ / ₈	18 ¹⁷ / ₃₂
36	12	Prefix(t)-12-(*)-HB45-36	32 ¹¹ / ₁₆	13 ⁹ / ₁₆	19 ¹ / ₈
36	18	Prefix(t)-18-(*)-HB45-36	34 ¹³ / ₁₆	14 ⁷ / ₁₆	20 ³ / ₈
36	24	Prefix(t)-24-(*)-HB45-36	36 ¹⁵ / ₁₆	15 ⁵ / ₁₆	21 ⁵ / ₈
36	30	Prefix(t)-30-(*)-HB45-36	39 ¹ / ₁₆	16 ³ / ₁₆	22 ⁷ / ₈
36	36	Prefix(t)-36-(*)-HB45-36	41 ³ / ₁₆	17 ¹ / ₁₆	24 ¹ / ₈

(t) Insert side rail height. (*) Insert bottom style to complete cat. no. Includes 1 pair of splice plates with hardware.

Selection guide

- Prefix: ALUF (aluminum), SPUF (pregalv.), SHUF (hot-dip galv.), SSUF (stainless steel)
- Inside tray widths: 06, 09, 12, 18, 24, 30, 36 in.
- Angle: 45°
- Nominal radius: 12, 24, 36 in.
- Bottom styles: V– ventilated, S– solid
- Side rail height: 2, 3, 6 in.

Part numbering system

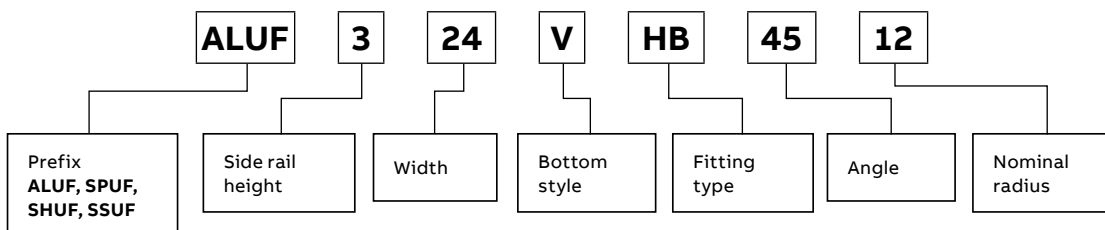

One-piece tray

30° Horizontal bend fittings

30° Horizontal bend

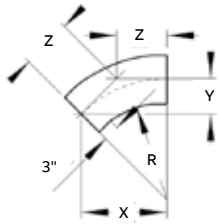

Nominal radius (in.)	Nominal width (in.)	Cat. no.	Dimensions (in.)		
			X	Y	Z
12	06	Prefix(t)-06-(*)-HB30-12	11 ⁵ / ₈	3 ¹ / ₈	6 ³ / ₁₆
12	09	Prefix(t)-09-(*)-HB30-12	12 ⁹ / ₁₆	3 ⁵ / ₁₆	6 ¹⁹ / ₃₂
12	12	Prefix(t)-12-(*)-HB30-12	13 ¹ / ₂	3 ¹ / ₂	7
12	18	Prefix(t)-18-(*)-HB30-12	14 ¹ / ₈	3 ¹⁵ / ₁₆	7 ¹³ / ₁₆
12	24	Prefix(t)-24-(*)-HB30-12	16 ¹ / ₈	4 ⁵ / ₁₆	8 ³ / ₈
12	30	Prefix(t)-30-(*)-HB30-12	17 ¹ / ₈	4 ¹¹ / ₁₆	9 ⁷ / ₁₆
12	36	Prefix(t)-36-(*)-HB30-12	19 ¹ / ₈	5 ¹ / ₈	10 ¹ / ₄
24	06	Prefix(t)-06-(*)-HB30-24	17 ¹ / ₈	4 ¹¹ / ₁₆	9 ⁷ / ₁₆
24	09	Prefix(t)-09-(*)-HB30-24	18 ³ / ₈	4 ²⁹ / ₃₂	9 ²⁷ / ₃₂
24	12	Prefix(t)-12-(*)-HB30-24	19 ¹ / ₈	5 ¹ / ₈	10 ¹ / ₄
24	18	Prefix(t)-18-(*)-HB30-24	20 ⁵ / ₈	5 ¹ / ₂	11 ¹ / ₁₆
24	24	Prefix(t)-24-(*)-HB30-24	22 ¹ / ₈	5 ¹⁵ / ₁₆	11 ¹³ / ₁₆
24	30	Prefix(t)-30-(*)-HB30-24	23 ¹ / ₈	6 ⁵ / ₁₆	12 ³ / ₈
24	36	Prefix(t)-36-(*)-HB30-24	25 ¹ / ₈	6 ³ / ₄	13 ⁷ / ₁₆
36	06	Prefix(t)-06-(*)-HB30-36	23 ¹ / ₈	6 ⁵ / ₁₆	12 ³ / ₈
36	09	Prefix(t)-09-(*)-HB30-36	24 ³ / ₈	6 ¹⁷ / ₃₂	13 ¹ / ₃₂
36	12	Prefix(t)-12-(*)-HB30-36	25 ¹ / ₈	6 ³ / ₄	13 ⁷ / ₁₆
36	18	Prefix(t)-18-(*)-HB30-36	26 ¹ / ₈	7 ¹ / ₄	14 ¹ / ₄
36	24	Prefix(t)-24-(*)-HB30-36	28 ¹ / ₈	7 ¹ / ₂	15 ⁵ / ₁₆
36	30	Prefix(t)-30-(*)-HB30-36	29 ¹ / ₈	7 ¹⁵ / ₁₆	15 ⁷ / ₈
36	36	Prefix(t)-36-(*)-HB30-36	31 ¹ / ₈	8 ⁵ / ₁₆	16 ¹¹ / ₁₆

(t) Insert side rail height. (*) Insert bottom style to complete cat. no. Includes 1 pair of splice plates with hardware.

Selection guide

- Prefix: ALUF (aluminum), SPUF (pregalv.), SHUF (hot-dip galv.), SSUF (stainless steel)
- Inside tray widths: 06, 09, 12, 18, 24, 30, 36 in.
- Angle: 30°
- Nominal radius: 12, 24, 36 in.
- Bottom styles: V- ventilated, S- solid
- Side rail height: 2, 3, 6 in.

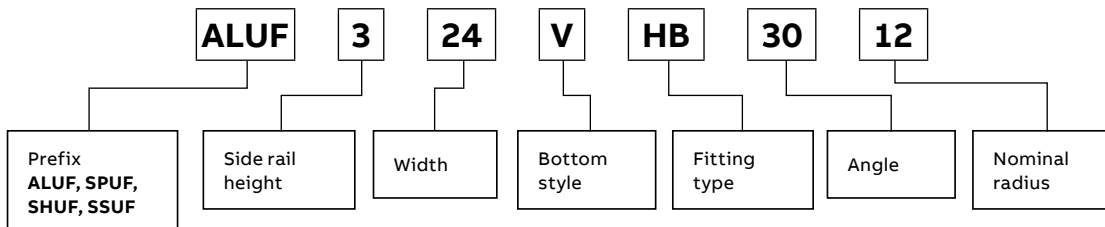

Part numbering system



One-piece tray

Horizontal tee fittings

Horizontal tee

	Nominal radius (in.)	Nominal width (in.)	Cat. no.	Dimensions (in.)	
				X	Y
 <p>Solid</p>	12	06	Prefix(t)-06-(*)-HT12	15	30
	12	09	Prefix(t)-09-(*)-HT12	16½	33
	12	12	Prefix(t)-12-(*)-HT12	18	36
	12	18	Prefix(t)-18-(*)-HT12	21	42
	12	24	Prefix(t)-24-(*)-HT12	24	48
	12	30	Prefix(t)-30-(*)-HT12	27	54
	12	36	Prefix(t)-36-(*)-HT12	30	60
 <p>Ventilated</p>	24	06	Prefix(t)-06-(*)-HT24	27	54
	24	09	Prefix(t)-09-(*)-HT24	28½	57
	24	12	Prefix(t)-12-(*)-HT24	30	60
	24	18	Prefix(t)-18-(*)-HT24	33	66
	24	24	Prefix(t)-24-(*)-HT24	36	72
	24	30	Prefix(t)-30-(*)-HT24	39	78
	24	36	Prefix(t)-36-(*)-HT24	42	84
	36	06	Prefix(t)-06-(*)-HT36	39	78
	36	09	Prefix(t)-09-(*)-HT36	40½	81
	36	12	Prefix(t)-12-(*)-HT36	42	84
	36	18	Prefix(t)-18-(*)-HT36	45	90
	36	24	Prefix(t)-24-(*)-HT36	48	96
	36	30	Prefix(t)-30-(*)-HT36	51	102
36	36	Prefix(t)-36-(*)-HT36	54	108	

(t) Insert side rail height. (*) Insert bottom style to complete cat. no.
 Tees include 2 pairs/crosses include 3 pairs of splice plates with hardware.

Dimensions

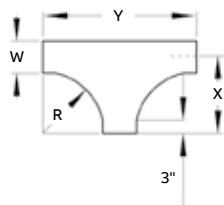

Selection guide

- Prefix: ALUF (aluminum), SPUF (pregalv.), SHUF (hot-dip galv.), SSUF (stainless steel)
- Inside tray widths: 06, 09, 12, 18, 24, 30, 36 in.
- Nominal radius: 12, 24, 36 in.
- Bottom styles: V– ventilated, S– solid
- Side rail height: 2, 3, 6 in.

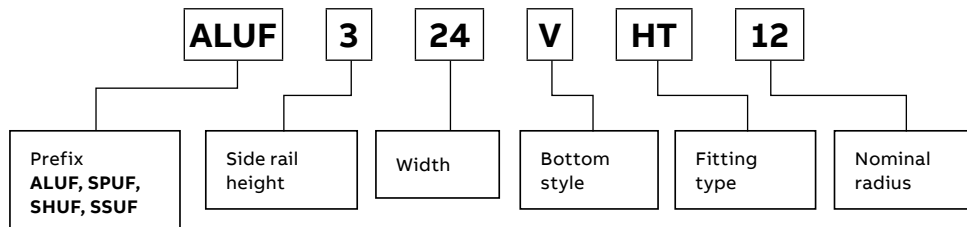

Part numbering system



One-piece tray

Horizontal cross fittings

Horizontal cross

	Nominal radius (in.)	Nominal width (in.)	Cat. no.	Dimensions (in.)	
				X	Y
	12	06	Prefix(t)-06-(*)-HX12	15	30
	12	09	Prefix(t)-09-(*)-HX12	16½	33
	12	12	Prefix(t)-12-(*)-HX12	18	36
	12	18	Prefix(t)-18-(*)-HX12	21	42
	12	24	Prefix(t)-24-(*)-HX12	24	48
	12	30	Prefix(t)-30-(*)-HX12	27	54
	12	36	Prefix(t)-36-(*)-HX12	30	60
	24	06	Prefix(t)-06-(*)-HX24	27	54
	24	09	Prefix(t)-09-(*)-HX24	28½	57
	24	12	Prefix(t)-12-(*)-HX24	30	60
	24	18	Prefix(t)-18-(*)-HX24	33	66
	24	24	Prefix(t)-24-(*)-HX24	36	72
	24	30	Prefix(t)-30-(*)-HX24	39	78
	24	36	Prefix(t)-36-(*)-HX24	42	84
	36	06	Prefix(t)-06-(*)-HX36	39	78
	36	09	Prefix(t)-09-(*)-HX36	40½	81
	36	12	Prefix(t)-12-(*)-HX36	42	84
	36	18	Prefix(t)-18-(*)-HX36	45	90
	36	24	Prefix(t)-24-(*)-HX36	48	96
	36	30	Prefix(t)-30-(*)-HX36	51	102
36	36	Prefix(t)-36-(*)-HX36	54	108	

(t) Insert side rail height. (*) Insert bottom style to complete cat. no.
 Tees include 2 pairs / crosses include 3 pairs of splice plates with hardware.

Dimensions

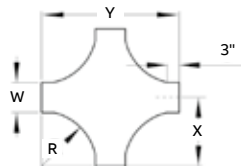

Selection guide

- Prefix: ALUF (aluminum), SPUF (pregalv.), SHUF (hot-dip galv.), SSUF (stainless steel)
- Inside tray widths: 06, 09, 12, 18, 24, 30, 36 in.
- Nominal radius: 12, 24, 36 in.
- Bottom styles: V– ventilated, S– solid
- Side rail height: 2, 3, 6 in.

Part numbering system

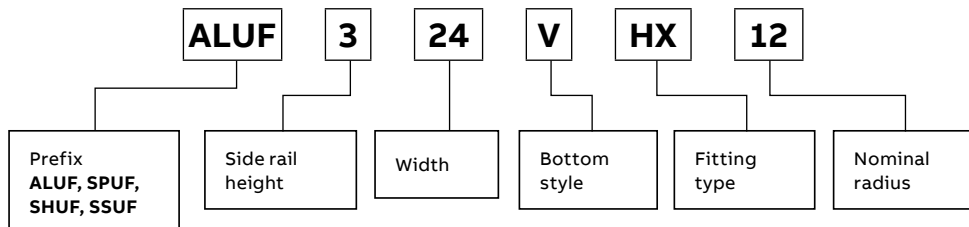

One-piece tray

Horizontal reducing tee fittings

Horizontal reducing tee

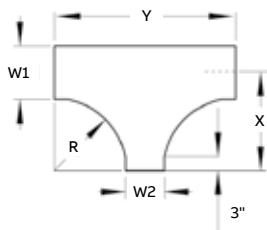

Widths (in.)			Dimensions (in.)					
			(+12 in. Nominal radius)		(+24 in. Nominal radius)		(+36 in. Nominal radius)	
W1	W2	Cat. no.	X	Y	X	Y	X	Y
36	30	Prefix(+)-3630-(*)-RT(+)	30	54	42	78	54	102
36	24	Prefix(+)-3624-(*)-RT(+)	30	48	42	72	54	96
36	18	Prefix(+)-3618-(*)-RT(+)	30	42	42	66	54	90
36	12	Prefix(+)-3612-(*)-RT(+)	30	36	42	60	54	84
36	09	Prefix(+)-3609-(*)-RT(+)	30	33	42	57	54	81
36	06	Prefix(+)-3606-(*)-RT(+)	30	30	42	54	54	78
30	24	Prefix(+)-3024-(*)-RT(+)	27	48	39	72	51	96
30	18	Prefix(+)-3018-(*)-RT(+)	27	42	39	66	51	90
30	12	Prefix(+)-3012-(*)-RT(+)	27	36	39	60	51	84
30	09	Prefix(+)-3009-(*)-RT(+)	27	33	39	57	51	81
30	06	Prefix(+)-3006-(*)-RT(+)	27	30	39	54	51	78
24	18	Prefix(+)-2418-(*)-RT(+)	24	42	36	66	48	90
24	12	Prefix(+)-2412-(*)-RT(+)	24	36	36	60	48	84
24	09	Prefix(+)-2409-(*)-RT(+)	24	33	36	57	48	81
24	06	Prefix(+)-2406-(*)-RT(+)	24	30	36	54	48	78
18	12	Prefix(+)-1812-(*)-RT(+)	21	36	33	60	45	84
18	09	Prefix(+)-1809-(*)-RT(+)	21	33	33	57	45	81
18	06	Prefix(+)-1806-(*)-RT(+)	21	30	33	54	45	78
12	09	Prefix(+)-1209-(*)-RT(+)	18	33	30	57	42	81
12	06	Prefix(+)-1206-(*)-RT(+)	18	30	30	54	42	78
09	06	Prefix(+)-906-(*)-RT(+)	16½	30	28½	54	40½	78

(f) Insert side rail height. (*) Insert bottom style (+) Insert radius (12 in. – 36 in.) to complete cat. no.
Includes 2 pairs of splice plates with hardware.

Selection guide

- Prefix: ALUF (aluminum), SPUF (pregalv.), SHUF (hot-dip galv.), SSUF (stainless steel)
- Tray widths W1: 36, 30, 24, 18, 12, 09 in.
- Tray widths W2: 30, 24, 18, 12, 09, 06 in.
- Nominal radius: 12, 24, 36 in.
- Bottom styles: V– ventilated, S– solid
- Side rail height: 2, 3, 6 in.

Part numbering system

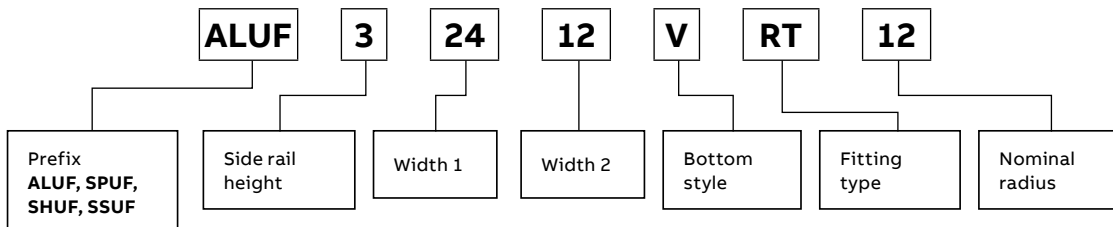

One-piece tray

Horizontal expanding tee fittings

Horizontal expanding tee

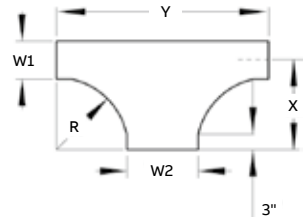

Widths (in.)			Dimensions (in.)					
W1	W2	Cat. no.	(+ 12 in. Nominal radius)		(+ 24 in. Nominal radius)		(+ 36 in. Nominal radius)	
			X	Y	X	Y	X	Y
30	36	Prefix(†)-3036-(*)-ET(+)	27	60	39	84	51	108
24	30	Prefix(†)-2430-(*)-ET(+)	24	54	36	78	48	102
24	36	Prefix(†)-2436-(*)-ET(+)	24	60	36	84	48	108
18	24	Prefix(†)-1824-(*)-ET(+)	21	48	33	72	45	96
18	30	Prefix(†)-1830-(*)-ET(+)	21	54	33	78	45	102
18	36	Prefix(†)-1836-(*)-ET(+)	21	60	33	84	45	108
12	18	Prefix(†)-1218-(*)-ET(+)	18	42	30	66	42	90
12	24	Prefix(†)-1224-(*)-ET(+)	18	48	30	72	42	96
12	30	Prefix(†)-1230-(*)-ET(+)	18	54	30	78	42	102
12	36	Prefix(†)-1236-(*)-ET(+)	18	60	30	84	42	108
09	12	Prefix(†)-0912-(*)-ET(+)	16½	36	28½	60	40½	84
09	18	Prefix(†)-0918-(*)-ET(+)	16½	42	28½	66	40½	90
09	24	Prefix(†)-0942-(*)-ET(+)	16½	48	28½	72	40½	96
09	30	Prefix(†)-0930-(*)-ET(+)	16½	54	28½	78	40½	102
09	36	Prefix(†)-0936-(*)-ET(+)	16½	60	28½	84	40½	108
06	09	Prefix(†)-0609-(*)-ET(+)	15	33	27	57	39	81
06	12	Prefix(†)-0612-(*)-ET(+)	15	36	27	60	39	84
06	18	Prefix(†)-0618-(*)-ET(+)	15	42	27	66	39	90
06	24	Prefix(†)-0624-(*)-ET(+)	15	48	27	72	39	96
06	30	Prefix(†)-0630-(*)-ET(+)	15	54	27	78	39	102
06	36	Prefix(†)-0636-(*)-ET(+)	15	60	27	84	39	108

(†) Insert side rail height. (*) Insert bottom style (+) Insert radius (12 in.–36 in.) to complete cat. no. Includes 2 pairs of splice plates with hardware.

Selection guide

- Prefix: SALUF (aluminum), SPUF (pregalv.), SHUF (hot-dip galv.), SSUF (stainless steel)
- Tray widths W1: 30, 24, 18, 12, 09, 06 in.
- Tray widths W2: 36, 30, 24, 18, 12, 09 in.
- Nominal radius: 12, 24, 36 in.
- Bottom styles: V– ventilated, S– solid
- Side rail height: 2, 3, 6 in.

Part numbering system

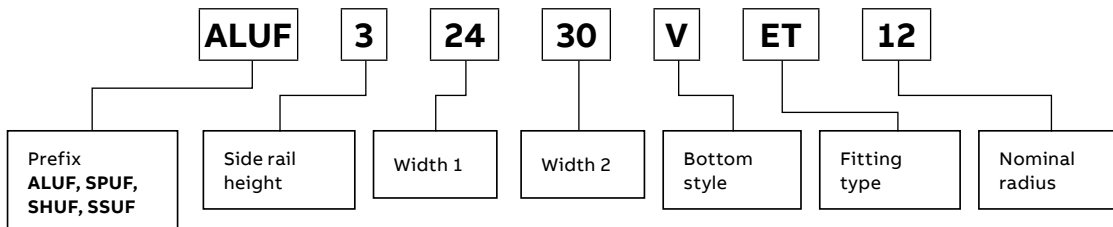

One-piece tray

Horizontal expanding cross fittings

Horizontal expanding cross

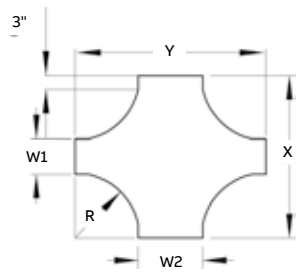

Widths (in.)			Dimensions (in.)					
W1	W2	Cat. no.	(+ 12 in. Nominal radius)		(+ 24 in. Nominal radius)		(+ 36 in. Nominal radius)	
			X	Y	X	Y	X	Y
30	36	Prefix(†)-3036-(*)-EX(+)	54	60	78	84	102	108
24	30	Prefix(†)-2430-(*)-EX(+)	48	54	72	78	96	102
24	36	Prefix(†)-2436-(*)-EX(+)	48	60	72	84	96	108
18	24	Prefix(†)-1824-(*)-EX(+)	42	48	66	72	90	96
18	30	Prefix(†)-1830-(*)-EX(+)	42	54	66	78	90	102
18	36	Prefix(†)-1836-(*)-EX(+)	42	60	66	84	90	108
12	18	Prefix(†)-1218-(*)-EX(+)	36	42	60	66	84	90
12	24	Prefix(†)-1224-(*)-EX(+)	36	48	60	72	84	96
12	30	Prefix(†)-1230-(*)-EX(+)	36	54	60	78	84	102
12	36	Prefix(†)-1236-(*)-EX(+)	36	60	60	84	84	108
09	12	Prefix(†)-0912-(*)-EX(+)	33	36	57	60	81	84
09	18	Prefix(†)-0918-(*)-EX(+)	33	42	57	66	81	90
09	24	Prefix(†)-0924-(*)-EX(+)	33	48	57	72	81	96
09	30	Prefix(†)-0930-(*)-EX(+)	33	54	57	78	81	102
09	36	Prefix(†)-0936-(*)-EX(+)	33	60	57	84	81	108
06	09	Prefix(†)-0609-(*)-EX(+)	30	33	54	57	78	81
06	12	Prefix(†)-0612-(*)-EX(+)	30	36	54	60	78	84
06	18	Prefix(†)-0618-(*)-EX(+)	30	42	54	66	78	90
06	24	Prefix(†)-0624-(*)-EX(+)	30	48	54	72	78	96
06	30	Prefix(†)-0630-(*)-EX(+)	30	54	54	78	78	102
06	36	Prefix(†)-0636-(*)-EX(+)	30	60	54	84	78	108

(†) Insert side rail height. (*) Insert bottom style (+) Insert radius (12 in.–36 in.) to complete cat. no. Includes 3 pairs of splice plates with hardware.

Selection guide

- Prefix: ALUF (aluminum), SPUF (pregalv.), SHUF (hot-dip galv.), SSUF (stainless steel)
- Tray widths W1: 30, 24, 18, 12, 09, 06 in.
- Tray widths W2: 36, 30, 24, 18, 12, 09 in.
- Nominal radius: 12, 24, 36 in.
- Bottom styles: V– ventilated, S– solid
- Side rail height: 2, 3, 6 in.

Part numbering system

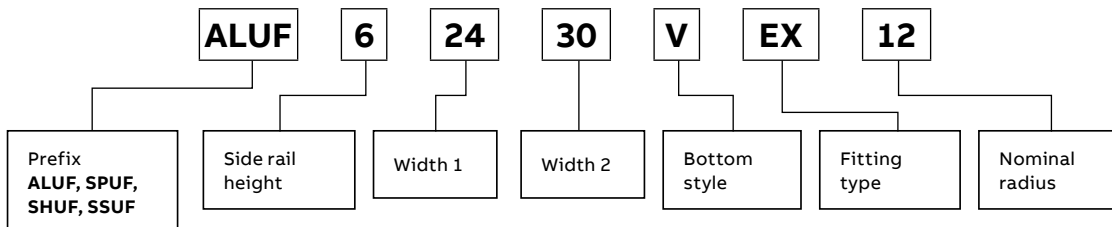

One-piece tray

90° Vertical bend fittings

90° Vertical bend

Selection guide

- Prefix: ALUF (aluminum), SPUF (pregalv.), SHUF (hot-dip galv.), SSUF (stainless steel)
- Inside tray widths: 06, 09, 12, 18, 24, 30, 36 in.
- Angle: 90°
- Nominal radius: 12, 24, 36 in.
- Bottom styles: V– ventilated, S– solid
- Side rail height: 2, 3, 6 in.

	Nominal radius (in.)	Nominal width (in.)	Cat. no.	Dimensions (in.)											
				(+ VO side rail height			2 in.			3 in.			(+ VI side rail depth		
				2 in., 3 in., 6 in.	2 in.	3 in.	6 in.	2 in.	3 in.	6 in.	2 in.	3 in.	6 in.		
	12	06	Prefix(+)-06-(*)-(+)90-12	12	12	12	13 ⁷ / ₁₆	13 ⁷ / ₁₆	13 ⁷ / ₁₆	15 ⁵ / ₁₆	15 ⁵ / ₁₆	15 ⁵ / ₁₆	18 ³ / ₁₆	18 ³ / ₁₆	18 ³ / ₁₆
	12	09	Prefix(+)-09-(*)-(+)90-12	12	12	12	13 ⁷ / ₁₆	13 ⁷ / ₁₆	13 ⁷ / ₁₆	15 ⁵ / ₁₆	15 ⁵ / ₁₆	15 ⁵ / ₁₆	18 ³ / ₁₆	18 ³ / ₁₆	18 ³ / ₁₆
	12	12	Prefix(+)-12-(*)-(+)90-12	12	12	12	13 ⁷ / ₁₆	13 ⁷ / ₁₆	13 ⁷ / ₁₆	15 ⁵ / ₁₆	15 ⁵ / ₁₆	15 ⁵ / ₁₆	18 ³ / ₁₆	18 ³ / ₁₆	18 ³ / ₁₆
	12	18	Prefix(+)-18-(*)-(+)90-12	12	12	12	13 ⁷ / ₁₆	13 ⁷ / ₁₆	13 ⁷ / ₁₆	15 ⁵ / ₁₆	15 ⁵ / ₁₆	15 ⁵ / ₁₆	18 ³ / ₁₆	18 ³ / ₁₆	18 ³ / ₁₆
	12	24	Prefix(+)-24-(*)-(+)90-12	12	12	12	13 ⁷ / ₁₆	13 ⁷ / ₁₆	13 ⁷ / ₁₆	15 ⁵ / ₁₆	15 ⁵ / ₁₆	15 ⁵ / ₁₆	18 ³ / ₁₆	18 ³ / ₁₆	18 ³ / ₁₆
	12	36	Prefix(+)-36-(*)-(+)90-12	12	12	12	13 ⁷ / ₁₆	13 ⁷ / ₁₆	13 ⁷ / ₁₆	15 ⁵ / ₁₆	15 ⁵ / ₁₆	15 ⁵ / ₁₆	18 ³ / ₁₆	18 ³ / ₁₆	18 ³ / ₁₆
	24	06	Prefix(+)-06-(*)-(+)90-24	24	24	24	25 ⁷ / ₁₆	25 ⁷ / ₁₆	25 ⁷ / ₁₆	27 ⁷ / ₁₆	27 ⁷ / ₁₆	27 ⁷ / ₁₆	30 ³ / ₁₆	30 ³ / ₁₆	30 ³ / ₁₆
	24	09	Prefix(+)-09-(*)-(+)90-24	24	24	24	25 ⁷ / ₁₆	25 ⁷ / ₁₆	25 ⁷ / ₁₆	27 ⁷ / ₁₆	27 ⁷ / ₁₆	27 ⁷ / ₁₆	30 ³ / ₁₆	30 ³ / ₁₆	30 ³ / ₁₆
	24	12	Prefix(+)-12-(*)-(+)90-24	24	24	24	25 ⁷ / ₁₆	25 ⁷ / ₁₆	25 ⁷ / ₁₆	27 ⁷ / ₁₆	27 ⁷ / ₁₆	27 ⁷ / ₁₆	30 ³ / ₁₆	30 ³ / ₁₆	30 ³ / ₁₆
	24	18	Prefix(+)-18-(*)-(+)90-24	24	24	24	25 ⁷ / ₁₆	25 ⁷ / ₁₆	25 ⁷ / ₁₆	27 ⁷ / ₁₆	27 ⁷ / ₁₆	27 ⁷ / ₁₆	30 ³ / ₁₆	30 ³ / ₁₆	30 ³ / ₁₆
	24	24	Prefix(+)-24-(*)-(+)90-24	24	24	24	25 ⁷ / ₁₆	25 ⁷ / ₁₆	25 ⁷ / ₁₆	27 ⁷ / ₁₆	27 ⁷ / ₁₆	27 ⁷ / ₁₆	30 ³ / ₁₆	30 ³ / ₁₆	30 ³ / ₁₆
	24	30	Prefix(+)-30-(*)-(+)90-24	24	24	24	25 ⁷ / ₁₆	25 ⁷ / ₁₆	25 ⁷ / ₁₆	27 ⁷ / ₁₆	27 ⁷ / ₁₆	27 ⁷ / ₁₆	30 ³ / ₁₆	30 ³ / ₁₆	30 ³ / ₁₆
	24	36	Prefix(+)-36-(*)-(+)90-24	24	24	24	25 ⁷ / ₁₆	25 ⁷ / ₁₆	25 ⁷ / ₁₆	27 ⁷ / ₁₆	27 ⁷ / ₁₆	27 ⁷ / ₁₆	30 ³ / ₁₆	30 ³ / ₁₆	30 ³ / ₁₆
	36	06	Prefix(+)-06-(*)-(+)90-36	36	36	36	37 ⁷ / ₁₆	37 ⁷ / ₁₆	37 ⁷ / ₁₆	39 ⁵ / ₁₆	39 ⁵ / ₁₆	39 ⁵ / ₁₆	42 ³ / ₁₆	42 ³ / ₁₆	42 ³ / ₁₆
	36	09	Prefix(+)-09-(*)-(+)90-36	36	36	36	37 ⁷ / ₁₆	37 ⁷ / ₁₆	37 ⁷ / ₁₆	39 ⁵ / ₁₆	39 ⁵ / ₁₆	39 ⁵ / ₁₆	42 ³ / ₁₆	42 ³ / ₁₆	42 ³ / ₁₆
	36	12	Prefix(+)-12-(*)-(+)90-36	36	36	36	37 ⁷ / ₁₆	37 ⁷ / ₁₆	37 ⁷ / ₁₆	39 ⁵ / ₁₆	39 ⁵ / ₁₆	39 ⁵ / ₁₆	42 ³ / ₁₆	42 ³ / ₁₆	42 ³ / ₁₆
	36	18	Prefix(+)-18-(*)-(+)90-36	36	36	36	37 ⁷ / ₁₆	37 ⁷ / ₁₆	37 ⁷ / ₁₆	39 ⁵ / ₁₆	39 ⁵ / ₁₆	39 ⁵ / ₁₆	42 ³ / ₁₆	42 ³ / ₁₆	42 ³ / ₁₆
	36	24	Prefix(+)-24-(*)-(+)90-36	36	36	36	37 ⁷ / ₁₆	37 ⁷ / ₁₆	37 ⁷ / ₁₆	39 ⁵ / ₁₆	39 ⁵ / ₁₆	39 ⁵ / ₁₆	42 ³ / ₁₆	42 ³ / ₁₆	42 ³ / ₁₆
	36	30	Prefix(+)-30-(*)-(+)90-36	36	36	36	37 ⁷ / ₁₆	37 ⁷ / ₁₆	37 ⁷ / ₁₆	39 ⁵ / ₁₆	39 ⁵ / ₁₆	39 ⁵ / ₁₆	42 ³ / ₁₆	42 ³ / ₁₆	42 ³ / ₁₆
	36	36	Prefix(+)-36-(*)-(+)90-36	36	36	36	37 ⁷ / ₁₆	37 ⁷ / ₁₆	37 ⁷ / ₁₆	39 ⁵ / ₁₆	39 ⁵ / ₁₆	39 ⁵ / ₁₆	42 ³ / ₁₆	42 ³ / ₁₆	42 ³ / ₁₆

(†) Insert side rail height. (*) Insert bottom style (†) Insert “VO” for vertical outside or “VI” for vertical inside to complete cat. no. Includes 1 pair of splice plates with hardware.

Part numbering system

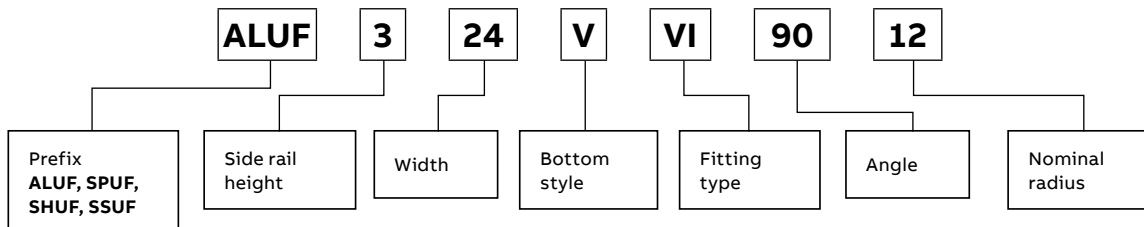

One-piece tray

60° Vertical bend fittings

60° Vertical bend

Selection guide

- Prefix: ALUF (aluminum), SPUF (pregalv.), SHUF (hot-dip galv.), SSUF (stainless steel)
- Inside tray widths: 06, 09, 12, 18, 24, 30, 36 in.
- Angle: 60°
- Nominal radius: 12, 24, 36 in.
- Bottom styles: V– ventilated, S– solid
- Side rail height: 2, 3, 6 in.

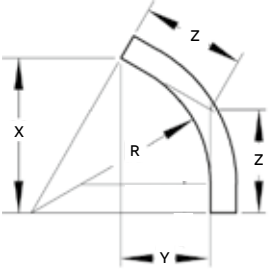
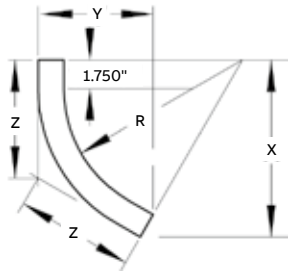
	Nominal radius (in.)	Nominal width (in.)	Cat. no.	Dimensions (in.)											
				(+ VO side rail height			(+ VI side rail depth								
				2 in., 3 in., 6 in.			2 in.			3 in.			6 in.		
				X	Y	Z	X	Y	Z	X	Y	Z	X	Y	Z
	12	06	Prefix(+)-06-(*)-(+)-60-12	10 ³ / ₈	6	6 ¹⁵ / ₁₆	12	7 ⁷ / ₈	8	13 ³ / ₂	9 ⁹ / ₈	9	15 ³ / ₄	12 ³ / ₁₆	10 ¹ / ₂
	12	09	Prefix(+)-09-(*)-(+)-60-12	10 ³ / ₈	6	6 ¹⁵ / ₁₆	12	7 ⁷ / ₈	8	13 ³ / ₂	9 ⁹ / ₈	9	15 ³ / ₄	12 ³ / ₁₆	10 ¹ / ₂
	12	12	Prefix(+)-12-(*)-(+)-60-12	10 ³ / ₈	6	6 ¹⁵ / ₁₆	12	7 ⁷ / ₈	8	13 ³ / ₂	9 ⁹ / ₈	9	15 ³ / ₄	12 ³ / ₁₆	10 ¹ / ₂
	12	18	Prefix(+)-18-(*)-(+)-60-12	10 ³ / ₈	6	6 ¹⁵ / ₁₆	12	7 ⁷ / ₈	8	13 ³ / ₂	9 ⁹ / ₈	9	15 ³ / ₄	12 ³ / ₁₆	10 ¹ / ₂
	12	24	Prefix(+)-24-(*)-(+)-60-12	10 ³ / ₈	6	6 ¹⁵ / ₁₆	12	7 ⁷ / ₈	8	13 ³ / ₂	9 ⁹ / ₈	9	15 ³ / ₄	12 ³ / ₁₆	10 ¹ / ₂
	12	30	Prefix(+)-30-(*)-(+)-60-12	10 ³ / ₈	6	6 ¹⁵ / ₁₆	12	7 ⁷ / ₈	8	13 ³ / ₂	9 ⁹ / ₈	9	15 ³ / ₄	12 ³ / ₁₆	10 ¹ / ₂
	12	36	Prefix(+)-36-(*)-(+)-60-12	10 ³ / ₈	6	6 ¹⁵ / ₁₆	12	7 ⁷ / ₈	8	13 ³ / ₂	9 ⁹ / ₈	9	15 ³ / ₄	12 ³ / ₁₆	10 ¹ / ₂
	24	06	Prefix(+)-06-(*)-(+)-60-24	20 ¹³ / ₁₆	12	13 ³ / ₈	22 ⁷ / ₁₆	13 ⁷ / ₈	14 ¹⁵ / ₁₆	23 ¹⁵ / ₁₆	15 ⁵ / ₈	15 ¹⁵ / ₁₆	26 ³ / ₈	18 ³ / ₁₆	17 ⁷ / ₁₆
	24	09	Prefix(+)-09-(*)-(+)-60-24	20 ¹³ / ₁₆	12	13 ³ / ₈	22 ⁷ / ₁₆	13 ⁷ / ₈	14 ¹⁵ / ₁₆	23 ¹⁵ / ₁₆	15 ⁵ / ₈	15 ¹⁵ / ₁₆	26 ³ / ₈	18 ³ / ₁₆	17 ⁷ / ₁₆
	24	12	Prefix(+)-12-(*)-(+)-60-24	20 ¹³ / ₁₆	12	13 ³ / ₈	22 ⁷ / ₁₆	13 ⁷ / ₈	14 ¹⁵ / ₁₆	23 ¹⁵ / ₁₆	15 ⁵ / ₈	15 ¹⁵ / ₁₆	26 ³ / ₈	18 ³ / ₁₆	17 ⁷ / ₁₆
	24	18	Prefix(+)-18-(*)-(+)-60-24	20 ¹³ / ₁₆	12	13 ³ / ₈	22 ⁷ / ₁₆	13 ⁷ / ₈	14 ¹⁵ / ₁₆	23 ¹⁵ / ₁₆	15 ⁵ / ₈	15 ¹⁵ / ₁₆	26 ³ / ₈	18 ³ / ₁₆	17 ⁷ / ₁₆
	24	24	Prefix(+)-24-(*)-(+)-60-24	20 ¹³ / ₁₆	12	13 ³ / ₈	22 ⁷ / ₁₆	13 ⁷ / ₈	14 ¹⁵ / ₁₆	23 ¹⁵ / ₁₆	15 ⁵ / ₈	15 ¹⁵ / ₁₆	26 ³ / ₈	18 ³ / ₁₆	17 ⁷ / ₁₆
24	30	Prefix(+)-30-(*)-(+)-60-24	20 ¹³ / ₁₆	12	13 ³ / ₈	22 ⁷ / ₁₆	13 ⁷ / ₈	14 ¹⁵ / ₁₆	23 ¹⁵ / ₁₆	15 ⁵ / ₈	15 ¹⁵ / ₁₆	26 ³ / ₈	18 ³ / ₁₆	17 ⁷ / ₁₆	
24	36	Prefix(+)-36-(*)-(+)-60-24	20 ¹³ / ₁₆	12	13 ³ / ₈	22 ⁷ / ₁₆	13 ⁷ / ₈	14 ¹⁵ / ₁₆	23 ¹⁵ / ₁₆	15 ⁵ / ₈	15 ¹⁵ / ₁₆	26 ³ / ₈	18 ³ / ₁₆	17 ⁷ / ₁₆	
	36	06	Prefix(+)-06-(*)-(+)-60-36	31 ³ / ₁₆	18	20 ¹³ / ₁₆	32 ¹³ / ₁₆	19 ⁷ / ₈	21 ⁷ / ₈	34 ⁵ / ₁₆	21 ⁵ / ₈	22 ⁷ / ₈	36 ¹ / ₂	24 ³ / ₁₆	24 ³ / ₈
	36	09	Prefix(+)-09-(*)-(+)-60-36	31 ³ / ₁₆	18	20 ¹³ / ₁₆	32 ¹³ / ₁₆	19 ⁷ / ₈	21 ⁷ / ₈	34 ⁵ / ₁₆	21 ⁵ / ₈	22 ⁷ / ₈	36 ¹ / ₂	24 ³ / ₁₆	24 ³ / ₈
	36	12	Prefix(+)-12-(*)-(+)-60-36	31 ³ / ₁₆	18	20 ¹³ / ₁₆	32 ¹³ / ₁₆	19 ⁷ / ₈	21 ⁷ / ₈	34 ⁵ / ₁₆	21 ⁵ / ₈	22 ⁷ / ₈	36 ¹ / ₂	24 ³ / ₁₆	24 ³ / ₈
	36	18	Prefix(+)-18-(*)-(+)-60-36	31 ³ / ₁₆	18	20 ¹³ / ₁₆	32 ¹³ / ₁₆	19 ⁷ / ₈	21 ⁷ / ₈	34 ⁵ / ₁₆	21 ⁵ / ₈	22 ⁷ / ₈	36 ¹ / ₂	24 ³ / ₁₆	24 ³ / ₈
	36	24	Prefix(+)-24-(*)-(+)-60-36	31 ³ / ₁₆	18	20 ¹³ / ₁₆	32 ¹³ / ₁₆	19 ⁷ / ₈	21 ⁷ / ₈	34 ⁵ / ₁₆	21 ⁵ / ₈	22 ⁷ / ₈	36 ¹ / ₂	24 ³ / ₁₆	24 ³ / ₈
	36	30	Prefix(+)-30-(*)-(+)-60-36	31 ³ / ₁₆	18	20 ¹³ / ₁₆	32 ¹³ / ₁₆	19 ⁷ / ₈	21 ⁷ / ₈	34 ⁵ / ₁₆	21 ⁵ / ₈	22 ⁷ / ₈	36 ¹ / ₂	24 ³ / ₁₆	24 ³ / ₈
	36	36	Prefix(+)-36-(*)-(+)-60-36	31 ³ / ₁₆	18	20 ¹³ / ₁₆	32 ¹³ / ₁₆	19 ⁷ / ₈	21 ⁷ / ₈	34 ⁵ / ₁₆	21 ⁵ / ₈	22 ⁷ / ₈	36 ¹ / ₂	24 ³ / ₁₆	24 ³ / ₈

(+) Insert side rail height. (*) Insert bottom style (+) Insert "VO" for vertical outside or "VI" for vertical inside to complete cat. no. Includes 1 pair of splice plates with hardware.

Part numbering system

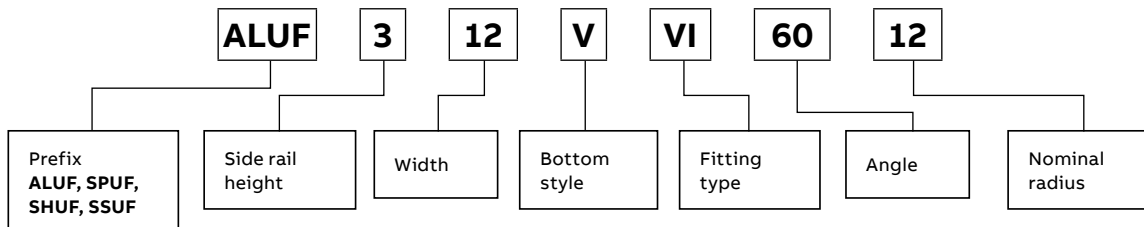

One-piece tray

45° Vertical bend fittings

45° Vertical bend

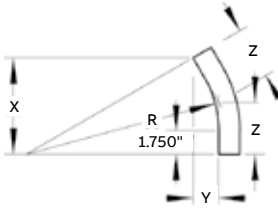
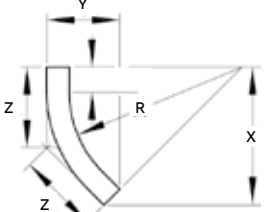
	Nominal radius (in.)	Nominal width (in.)	Cat. no.	Dimensions (in.)											
				(+ VO side rail height			2 in.			(+ VI side rail depth					
				2 in., 3 in., 6 in.			3 in.			6 in.					
Outside bend ventilated 	12	06	Prefix(+)-06-(*)-(+)-45-12	8½	3½	5	9 ¹³ / ₁₆	5¾	5¾	11 ¹ / ₁₆	7½	6 ¹¹ / ₁₆	12 ⁷ / ₈	9 ¹¹ / ₁₆	7 ⁹ / ₁₆
	12	09	Prefix(+)-09-(*)-(+)-45-12	8½	3½	5	9 ¹³ / ₁₆	5¾	5¾	11 ¹ / ₁₆	7½	6 ¹¹ / ₁₆	12 ⁷ / ₈	9 ¹¹ / ₁₆	7 ⁹ / ₁₆
	12	12	Prefix(+)-12-(*)-(+)-45-12	8½	3½	5	9 ¹³ / ₁₆	5¾	5¾	11 ¹ / ₁₆	7½	6 ¹¹ / ₁₆	12 ⁷ / ₈	9 ¹¹ / ₁₆	7 ⁹ / ₁₆
	12	18	Prefix(+)-18-(*)-(+)-45-12	8½	3½	5	9 ¹³ / ₁₆	5¾	5¾	11 ¹ / ₁₆	7½	6 ¹¹ / ₁₆	12 ⁷ / ₈	9 ¹¹ / ₁₆	7 ⁹ / ₁₆
	12	24	Prefix(+)-24-(*)-(+)-45-12	8½	3½	5	9 ¹³ / ₁₆	5¾	5¾	11 ¹ / ₁₆	7½	6 ¹¹ / ₁₆	12 ⁷ / ₈	9 ¹¹ / ₁₆	7 ⁹ / ₁₆
	12	30	Prefix(+)-30-(*)-(+)-45-12	8½	3½	5	9 ¹³ / ₁₆	5¾	5¾	11 ¹ / ₁₆	7½	6 ¹¹ / ₁₆	12 ⁷ / ₈	9 ¹¹ / ₁₆	7 ⁹ / ₁₆
Inside bend ventilated 	12	36	Prefix(+)-36-(*)-(+)-45-12	8½	3½	5	9 ¹³ / ₁₆	5¾	5¾	11 ¹ / ₁₆	7½	6 ¹¹ / ₁₆	12 ⁷ / ₈	9 ¹¹ / ₁₆	7 ⁹ / ₁₆
	24	06	Prefix(+)-06-(*)-(+)-45-24	17	7	9 ¹⁵ / ₁₆	18 ⁵ / ₁₆	8 ⁷ / ₈	10 ¹¹ / ₁₆	19½	10%	11 ⁷ / ₁₆	21 ³ / ₈	13 ³ / ₁₆	12½
	24	09	Prefix(+)-09-(*)-(+)-45-24	17	7	9 ¹⁵ / ₁₆	18 ⁵ / ₁₆	8 ⁷ / ₈	10 ¹¹ / ₁₆	19½	10%	11 ⁷ / ₁₆	21 ³ / ₈	13 ³ / ₁₆	12½
	24	12	Prefix(+)-12-(*)-(+)-45-24	17	7	9 ¹⁵ / ₁₆	18 ⁵ / ₁₆	8 ⁷ / ₈	10 ¹¹ / ₁₆	19½	10%	11 ⁷ / ₁₆	21 ³ / ₈	13 ³ / ₁₆	12½
	24	18	Prefix(+)-18-(*)-(+)-45-24	17	7	9 ¹⁵ / ₁₆	18 ⁵ / ₁₆	8 ⁷ / ₈	10 ¹¹ / ₁₆	19½	10%	11 ⁷ / ₁₆	21 ³ / ₈	13 ³ / ₁₆	12½
	24	24	Prefix(+)-24-(*)-(+)-45-24	17	7	9 ¹⁵ / ₁₆	18 ⁵ / ₁₆	8 ⁷ / ₈	10 ¹¹ / ₁₆	19½	10%	11 ⁷ / ₁₆	21 ³ / ₈	13 ³ / ₁₆	12½
	24	30	Prefix(+)-30-(*)-(+)-45-24	17	7	9 ¹⁵ / ₁₆	18 ⁵ / ₁₆	8 ⁷ / ₈	10 ¹¹ / ₁₆	19½	10%	11 ⁷ / ₁₆	21 ³ / ₈	13 ³ / ₁₆	12½
	24	36	Prefix(+)-36-(*)-(+)-45-24	17	7	9 ¹⁵ / ₁₆	18 ⁵ / ₁₆	8 ⁷ / ₈	10 ¹¹ / ₁₆	19½	10%	11 ⁷ / ₁₆	21 ³ / ₈	13 ³ / ₁₆	12½
	36	06	Prefix(+)-06-(*)-(+)-45-36	25 ⁷ / ₁₆	10 ⁹ / ₁₆	14 ¹⁵ / ₁₆	26 ¹³ / ₁₆	12 ⁷ / ₁₆	15 ¹¹ / ₁₆	28	14 ³ / ₁₆	16 ⁷ / ₁₆	29 ¹³ / ₁₆	16 ³ / ₄	17½
	36	09	Prefix(+)-09-(*)-(+)-45-36	25 ⁷ / ₁₆	10 ⁹ / ₁₆	14 ¹⁵ / ₁₆	26 ¹³ / ₁₆	12 ⁷ / ₁₆	15 ¹¹ / ₁₆	28	14 ³ / ₁₆	16 ⁷ / ₁₆	29 ¹³ / ₁₆	16 ³ / ₄	17½
	36	12	Prefix(+)-12-(*)-(+)-45-36	25 ⁷ / ₁₆	10 ⁹ / ₁₆	14 ¹⁵ / ₁₆	26 ¹³ / ₁₆	12 ⁷ / ₁₆	15 ¹¹ / ₁₆	28	14 ³ / ₁₆	16 ⁷ / ₁₆	29 ¹³ / ₁₆	16 ³ / ₄	17½
	36	18	Prefix(+)-18-(*)-(+)-45-36	25 ⁷ / ₁₆	10 ⁹ / ₁₆	14 ¹⁵ / ₁₆	26 ¹³ / ₁₆	12 ⁷ / ₁₆	15 ¹¹ / ₁₆	28	14 ³ / ₁₆	16 ⁷ / ₁₆	29 ¹³ / ₁₆	16 ³ / ₄	17½
	36	24	Prefix(+)-24-(*)-(+)-45-36	25 ⁷ / ₁₆	10 ⁹ / ₁₆	14 ¹⁵ / ₁₆	26 ¹³ / ₁₆	12 ⁷ / ₁₆	15 ¹¹ / ₁₆	28	14 ³ / ₁₆	16 ⁷ / ₁₆	29 ¹³ / ₁₆	16 ³ / ₄	17½
	36	30	Prefix(+)-30-(*)-(+)-45-36	25 ⁷ / ₁₆	10 ⁹ / ₁₆	14 ¹⁵ / ₁₆	26 ¹³ / ₁₆	12 ⁷ / ₁₆	15 ¹¹ / ₁₆	28	14 ³ / ₁₆	16 ⁷ / ₁₆	29 ¹³ / ₁₆	16 ³ / ₄	17½
	36	36	Prefix(+)-36-(*)-(+)-45-36	25 ⁷ / ₁₆	10 ⁹ / ₁₆	14 ¹⁵ / ₁₆	26 ¹³ / ₁₆	12 ⁷ / ₁₆	15 ¹¹ / ₁₆	28	14 ³ / ₁₆	16 ⁷ / ₁₆	29 ¹³ / ₁₆	16 ³ / ₄	17½

(†) Insert side rail height. (*) Insert bottom style (+) Insert "VO" for vertical outside or "VI" for vertical inside to complete cat. no. Includes 1 pair of splice plates with hardware.

Selection guide

- Prefix: ALUF (aluminum), SPUF (pregalv.), SHUF (hot-dip galv.), SSUF (stainless steel)
- Inside tray widths: 06, 09, 12, 18, 24, 30, 36 in.
- Angle: 45°
- Nominal radius: 12, 24, 36 in.
- Bottom styles: V– ventilated, S– solid
- Side rail height: 2, 3, 6 in.

Part numbering system

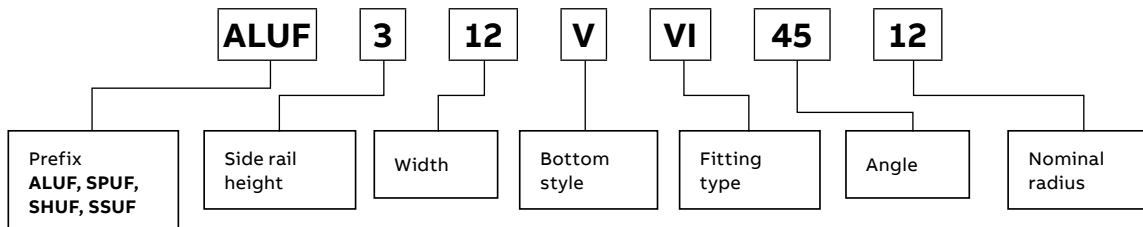

One-piece tray

30° Vertical bend fittings

30° Vertical bend

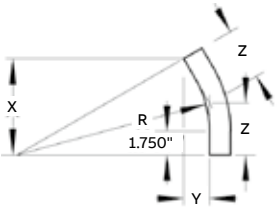
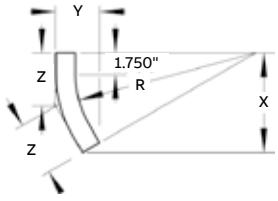
	Nominal radius (in.)	Nominal width (in.)	Cat. no.	Dimensions (in.)											
				(+ VO side rail height			2 in.			(+ VI Side Rail Depth					
				2 in., 3 in., 6 in.	2 in.	3 in.	6 in.								
Outside bend ventilated 	12	06	Prefix(+)-06-(*)-(+)30-12	6	1 ⁵ / ₁₆	3 ⁹ / ₁₆	6 ¹⁵ / ₁₆	3 ¹ / ₂	3 ¹¹ / ₁₆	7 ¹³ / ₁₆	5 ¹ / ₄	4 ³ / ₁₆	9 ¹ / ₈	7 ¹³ / ₁₆	4 ⁷ / ₈
	12	09	Prefix(+)-12-(*)-(+)30-12	6	1 ⁵ / ₁₆	3 ⁹ / ₁₆	6 ¹⁵ / ₁₆	3 ¹ / ₂	3 ¹¹ / ₁₆	7 ¹³ / ₁₆	5 ¹ / ₄	4 ³ / ₁₆	9 ¹ / ₈	7 ¹³ / ₁₆	4 ⁷ / ₈
	12	12	Prefix(+)-12-(*)-(+)30-12	6	1 ⁵ / ₁₆	3 ⁹ / ₁₆	6 ¹⁵ / ₁₆	3 ¹ / ₂	3 ¹¹ / ₁₆	7 ¹³ / ₁₆	5 ¹ / ₄	4 ³ / ₁₆	9 ¹ / ₈	7 ¹³ / ₁₆	4 ⁷ / ₈
	12	18	Prefix(+)-18-(*)-(+)30-12	6	1 ⁵ / ₁₆	3 ⁹ / ₁₆	6 ¹⁵ / ₁₆	3 ¹ / ₂	3 ¹¹ / ₁₆	7 ¹³ / ₁₆	5 ¹ / ₄	4 ³ / ₁₆	9 ¹ / ₈	7 ¹³ / ₁₆	4 ⁷ / ₈
	12	24	Prefix(+)-24-(*)-(+)30-12	6	1 ⁵ / ₁₆	3 ⁹ / ₁₆	6 ¹⁵ / ₁₆	3 ¹ / ₂	3 ¹¹ / ₁₆	7 ¹³ / ₁₆	5 ¹ / ₄	4 ³ / ₁₆	9 ¹ / ₈	7 ¹³ / ₁₆	4 ⁷ / ₈
	12	30	Prefix(+)-30-(*)-(+)30-12	6	1 ⁵ / ₁₆	3 ⁹ / ₁₆	6 ¹⁵ / ₁₆	3 ¹ / ₂	3 ¹¹ / ₁₆	7 ¹³ / ₁₆	5 ¹ / ₄	4 ³ / ₁₆	9 ¹ / ₈	7 ¹³ / ₁₆	4 ⁷ / ₈
	12	36	Prefix(+)-36-(*)-(+)30-12	6	1 ⁵ / ₁₆	3 ⁹ / ₁₆	6 ¹⁵ / ₁₆	3 ¹ / ₂	3 ¹¹ / ₁₆	7 ¹³ / ₁₆	5 ¹ / ₄	4 ³ / ₁₆	9 ¹ / ₈	7 ¹³ / ₁₆	4 ⁷ / ₈
Inside bend ventilated 	24	06	Prefix(+)-06-(*)-(+)30-24	12	3 ³ / ₁₆	6 ⁷ / ₁₆	12 ¹⁵ / ₁₆	5 ¹ / ₁₆	6 ¹⁵ / ₁₆	13 ¹³ / ₁₆	6 ¹³ / ₁₆	7 ³ / ₈	15 ¹ / ₈	9 ³ / ₈	8 ³ / ₁₆
	24	09	Prefix(+)-12-(*)-(+)30-24	12	3 ³ / ₁₆	6 ⁷ / ₁₆	12 ¹⁵ / ₁₆	5 ¹ / ₁₆	6 ¹⁵ / ₁₆	13 ¹³ / ₁₆	6 ¹³ / ₁₆	7 ³ / ₈	15 ¹ / ₈	9 ³ / ₈	8 ³ / ₁₆
	24	12	Prefix(+)-12-(*)-(+)30-24	12	3 ³ / ₁₆	6 ⁷ / ₁₆	12 ¹⁵ / ₁₆	5 ¹ / ₁₆	6 ¹⁵ / ₁₆	13 ¹³ / ₁₆	6 ¹³ / ₁₆	7 ³ / ₈	15 ¹ / ₈	9 ³ / ₈	8 ³ / ₁₆
	24	18	Prefix(+)-18-(*)-(+)30-24	12	3 ³ / ₁₆	6 ⁷ / ₁₆	12 ¹⁵ / ₁₆	5 ¹ / ₁₆	6 ¹⁵ / ₁₆	13 ¹³ / ₁₆	6 ¹³ / ₁₆	7 ³ / ₈	15 ¹ / ₈	9 ³ / ₈	8 ³ / ₁₆
	24	24	Prefix(+)-24-(*)-(+)30-24	12	3 ³ / ₁₆	6 ⁷ / ₁₆	12 ¹⁵ / ₁₆	5 ¹ / ₁₆	6 ¹⁵ / ₁₆	13 ¹³ / ₁₆	6 ¹³ / ₁₆	7 ³ / ₈	15 ¹ / ₈	9 ³ / ₈	8 ³ / ₁₆
	24	30	Prefix(+)-30-(*)-(+)30-24	12	3 ³ / ₁₆	6 ⁷ / ₁₆	12 ¹⁵ / ₁₆	5 ¹ / ₁₆	6 ¹⁵ / ₁₆	13 ¹³ / ₁₆	6 ¹³ / ₁₆	7 ³ / ₈	15 ¹ / ₈	9 ³ / ₈	8 ³ / ₁₆
	24	36	Prefix(+)-36-(*)-(+)30-24	12	3 ³ / ₁₆	6 ⁷ / ₁₆	12 ¹⁵ / ₁₆	5 ¹ / ₁₆	6 ¹⁵ / ₁₆	13 ¹³ / ₁₆	6 ¹³ / ₁₆	7 ³ / ₈	15 ¹ / ₈	9 ³ / ₈	8 ³ / ₁₆
	36	06	Prefix(+)-06-(*)-(+)30-36	18	4 ¹³ / ₁₆	9 ⁵ / ₈	18 ¹⁵ / ₁₆	6 ¹¹ / ₁₆	10 ¹ / ₂	19 ¹³ / ₁₆	8 ⁷ / ₁₆	10 ⁵ / ₈	21 ¹ / ₈	11	11 ¹ / ₁₆
	36	09	Prefix(+)-12-(*)-(+)30-36	18	4 ¹³ / ₁₆	9 ⁵ / ₈	18 ¹⁵ / ₁₆	6 ¹¹ / ₁₆	10 ¹ / ₂	19 ¹³ / ₁₆	8 ⁷ / ₁₆	10 ⁵ / ₈	21 ¹ / ₈	11	11 ¹ / ₁₆
	36	12	Prefix(+)-12-(*)-(+)30-36	18	4 ¹³ / ₁₆	9 ⁵ / ₈	18 ¹⁵ / ₁₆	6 ¹¹ / ₁₆	10 ¹ / ₂	19 ¹³ / ₁₆	8 ⁷ / ₁₆	10 ⁵ / ₈	21 ¹ / ₈	11	11 ¹ / ₁₆
	36	18	Prefix(+)-18-(*)-(+)30-36	18	4 ¹³ / ₁₆	9 ⁵ / ₈	18 ¹⁵ / ₁₆	6 ¹¹ / ₁₆	10 ¹ / ₂	19 ¹³ / ₁₆	8 ⁷ / ₁₆	10 ⁵ / ₈	21 ¹ / ₈	11	11 ¹ / ₁₆
	36	24	Prefix(+)-24-(*)-(+)30-36	18	4 ¹³ / ₁₆	9 ⁵ / ₈	18 ¹⁵ / ₁₆	6 ¹¹ / ₁₆	10 ¹ / ₂	19 ¹³ / ₁₆	8 ⁷ / ₁₆	10 ⁵ / ₈	21 ¹ / ₈	11	11 ¹ / ₁₆
	36	30	Prefix(+)-30-(*)-(+)30-36	18	4 ¹³ / ₁₆	9 ⁵ / ₈	18 ¹⁵ / ₁₆	6 ¹¹ / ₁₆	10 ¹ / ₂	19 ¹³ / ₁₆	8 ⁷ / ₁₆	10 ⁵ / ₈	21 ¹ / ₈	11	11 ¹ / ₁₆
36	36	Prefix(+)-36-(*)-(+)30-36	18	4 ¹³ / ₁₆	9 ⁵ / ₈	18 ¹⁵ / ₁₆	6 ¹¹ / ₁₆	10 ¹ / ₂	19 ¹³ / ₁₆	8 ⁷ / ₁₆	10 ⁵ / ₈	21 ¹ / ₈	11	11 ¹ / ₁₆	

(†) Insert side rail height. (*) Insert bottom style (+) Insert "VO" for vertical outside or "VI" for vertical inside to complete cat. no. Includes 1 pair of splice plates with hardware.

Selection guide

- Prefix: ALUF (aluminum), SPUF (pregalv.), SHUF (hot-dip galv.), SSUF (stainless steel)
- Inside tray widths: 06, 09, 12, 18, 24, 30, 36 in.
- Angle: 30°
- Nominal radius: 12, 24, 36 in.
- Bottom styles: V– ventilated, S– solid
- Side rail height: 2, 3, 6 in.

Part numbering system

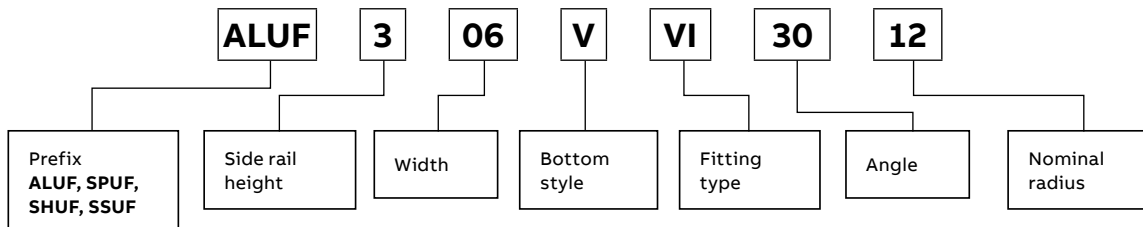

One-piece tray

Horizontal reducer fittings

Straight reducer solid



Straight reducer ventilated



Selection guide

- Prefix: ALUF (aluminum), SPUF (pregalv.), SHUF (hot-dip galv.), SSUF (stainless steel)
- Tray widths W1: 36, 30, 24, 18, 12, 09 in.
- Tray widths W2: 30, 24, 18, 12, 09, 06 in.
- Bottom styles: V– ventilated, S– solid
- Side rail height: 2, 3, 6 in.

Horizontal reducer

Widths (in.)		LH reducer	
W1	W2	Cat. no.	Dim. X (in.)
36	30	Prefix(†)-36-30-(*)-HLR	15 ⁷ / ₁₆
36	24	Prefix(†)-36-24-(*)-HLR	18 ¹⁵ / ₁₆
36	18	Prefix(†)-36-18-(*)-HLR	22 ³ / ₈
36	12	Prefix(†)-36-12-(*)-HLR	25 ⁷ / ₈
36	09	Prefix(†)-36-09-(*)-HLR	27 ¹⁹ / ₃₂
36	06	Prefix(†)-36-06-(*)-HLR	29 ⁹ / ₁₆
30	24	Prefix(†)-30-24-(*)-HLR	15 ⁷ / ₁₆
30	18	Prefix(†)-30-18-(*)-HLR	18 ¹⁵ / ₁₆
30	12	Prefix(†)-30-12-(*)-HLR	22 ³ / ₈
30	09	Prefix(†)-30-09-(*)-HLR	24 ¹ / ₈
30	06	Prefix(†)-30-06-(*)-HLR	25 ⁷ / ₈
24	18	Prefix(†)-24-18-(*)-HLR	15 ⁷ / ₁₆
24	12	Prefix(†)-24-12-(*)-HLR	18 ¹⁵ / ₁₆
24	09	Prefix(†)-24-09-(*)-HLR	20 ²¹ / ₃₂
24	06	Prefix(†)-24-06-(*)-HLR	22 ³ / ₈
18	12	Prefix(†)-18-12-(*)-HLR	15 ⁷ / ₁₆
18	09	Prefix(†)-18-09-(*)-HLR	17 ³ / ₁₆
18	06	Prefix(†)-18-06-(*)-HLR	18 ¹⁵ / ₁₆
12	09	Prefix(†)-12-09-(*)-HLR	15 ⁷ / ₁₆
12	06	Prefix(†)-12-06-(*)-HLR	13 ³ / ₄
09	06	Prefix(†)-09-06-(*)-HLR	13 ³ / ₄

Straight reducer	
Cat. no.	Dim. X (in.)
Prefix(†)-36-30-(*)-HSR	13 ³ / ₄
Prefix(†)-36-24-(*)-HSR	15 ⁷ / ₁₆
Prefix(†)-36-18-(*)-HSR	17 ³ / ₈
Prefix(†)-36-12-(*)-HSR	18 ⁵ / ₁₆
Prefix(†)-36-09-(*)-HSR	19 ¹ / ₂
Prefix(†)-36-06-(*)-HSR	20 ¹¹ / ₁₆
Prefix(†)-30-24-(*)-HSR	13 ³ / ₄
Prefix(†)-30-18-(*)-HSR	15 ⁷ / ₁₆
Prefix(†)-30-12-(*)-HSR	17 ³ / ₁₆
Prefix(†)-30-09-(*)-HSR	18 ¹ / ₁₆
Prefix(†)-30-06-(*)-HSR	18 ¹⁵ / ₁₆
Prefix(†)-24-18-(*)-HSR	13 ³ / ₄
Prefix(†)-24-12-(*)-HSR	15 ⁷ / ₁₆
Prefix(†)-24-09-(*)-HSR	16 ¹¹ / ₃₂
Prefix(†)-24-06-(*)-HSR	17 ³ / ₁₆
Prefix(†)-18-12-(*)-HSR	13 ³ / ₄
Prefix(†)-18-09-(*)-HSR	14 ¹⁹ / ₃₂
Prefix(†)-18-06-(*)-HSR	15 ⁷ / ₁₆
Prefix(†)-12-09-(*)-HSR	13 ³ / ₄
Prefix(†)-12-06-(*)-HSR	12 ⁷ / ₈
Prefix(†)-09-06-(*)-HSR	12 ⁷ / ₈

RH reducer	
Cat. no.	Dim. X (in.)
Prefix(†)-36-30-(*)-HRR	15 ⁷ / ₁₆
Prefix(†)-36-24-(*)-HRR	18 ¹⁵ / ₁₆
Prefix(†)-36-18-(*)-HRR	22 ³ / ₈
Prefix(†)-36-12-(*)-HRR	25 ⁷ / ₈
Prefix(†)-36-09-(*)-HRR	27 ¹⁹ / ₃₂
Prefix(†)-36-06-(*)-HRR	29 ⁹ / ₁₆
Prefix(†)-30-24-(*)-HRR	15 ⁷ / ₁₆
Prefix(†)-30-18-(*)-HRR	18 ¹⁵ / ₁₆
Prefix(†)-30-12-(*)-HRR	22 ³ / ₈
Prefix(†)-30-09-(*)-HRR	24 ¹ / ₈
Prefix(†)-30-06-(*)-HRR	25 ⁷ / ₈
Prefix(†)-24-18-(*)-HRR	15 ⁷ / ₁₆
Prefix(†)-24-12-(*)-HRR	18 ¹⁵ / ₁₆
Prefix(†)-24-09-(*)-HRR	20 ²¹ / ₃₂
Prefix(†)-24-06-(*)-HRR	22 ³ / ₈
Prefix(†)-18-12-(*)-HRR	15 ⁷ / ₁₆
Prefix(†)-18-09-(*)-HRR	17 ³ / ₁₆
Prefix(†)-18-06-(*)-HRR	18 ¹⁵ / ₁₆
Prefix(†)-12-09-(*)-HRR	15 ⁷ / ₁₆
Prefix(†)-12-06-(*)-HRR	13 ³ / ₄
Prefix(†)-09-06-(*)-HRR	13 ³ / ₄

Straight reducer

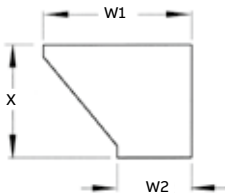

Offset reducer – right

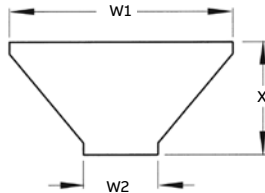

Offset reducer – left

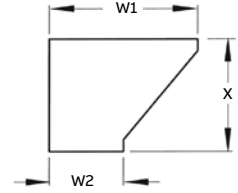

(†) Insert side rail height. (*) Insert bottom style to complete cat. no. Includes 1 pair of splice plates with hardware.

Part numbering system

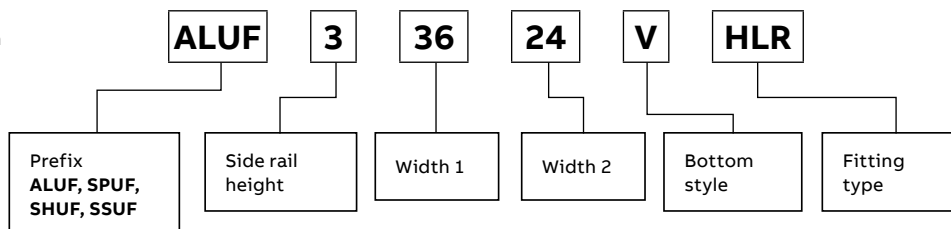

One-piece tray

45° Horizontal wye fittings



Selection guide

- Prefix: ALUF (aluminum), SPUF (pregalv.), SHUF (hot-dip galv.), SSUF (stainless steel)
- Inside tray widths: 06, 09, 12, 18, 24, 30, 36 in.
- Bottom styles: V- ventilated, S- solid
- Side rail height: 2, 3, 6 in.

45° Horizontal wye

Width (in.)	Left-hand wye cat. no.	Right-hand wye cat. no.	Dimensions (in.)		
			X	Y	Z
06	Prefix(t)-06-(*)-HYL	Prefix(t)-06-(*)-HYR	18 ⁹ / ₁₆	14 ¹³ / ₁₆	12 ⁷ / ₁₆
09	Prefix(t)-09-(*)-HYL	Prefix(t)-09-(*)-HYR	22 ¹⁷ / ₃₂	19 ²⁹ / ₃₂	15 ⁷ / ₁₆
12	Prefix(t)-12-(*)-HYL	Prefix(t)-12-(*)-HYR	26 ³ / ₄	25	18 ⁷ / ₁₆
18	Prefix(t)-18-(*)-HYL	Prefix(t)-18-(*)-HYR	35 ³ / ₄	35 ³ / ₄	24 ⁷ / ₁₆
24	Prefix(t)-24-(*)-HYL	Prefix(t)-24-(*)-HYR	43 ¹ / ₂	45 ¹ / ₂	30 ⁷ / ₁₆
30	Prefix(t)-30-(*)-HYL	Prefix(t)-30-(*)-HYR	52 ¹ / ₄	55 ³ / ₄	36 ⁷ / ₁₆
36	Prefix(t)-36-(*)-HYL	Prefix(t)-36-(*)-HYR	60 ¹ / ₁₆	66	42 ⁷ / ₁₆

Left hand wye

Right hand wye

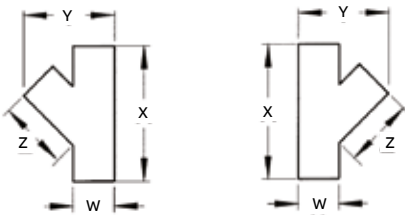

(t) Insert side rail height. (*) Insert bottom style to complete cat. no.
Includes 2 pairs of splice plates with hardware.

Part numbering system

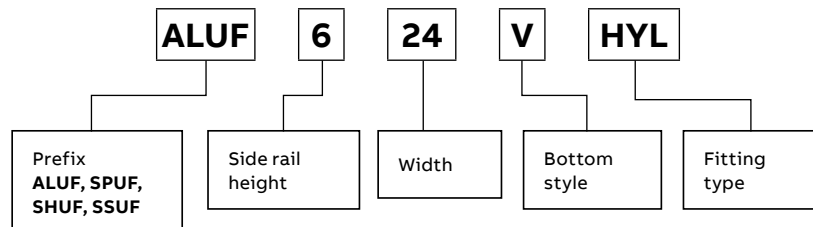

One-piece tray

Vertical tee up/down fittings

Vertical tee up/down

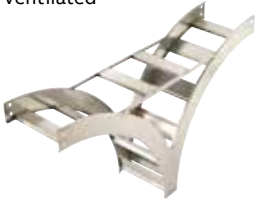
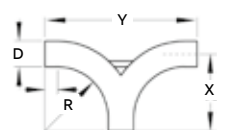
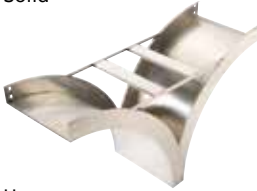
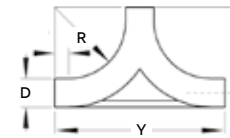
	Nominal radius (in.)	Nominal width (in.)	Vertical tee up cat. no.	Vertical tee down cat. no.	Dimensions (in.)					
					Side rail height "D"					
					2 in.		3 in.		6 in.	
					X	Y	X	Y	X	Y
Ventilated 	12	06	Prefix(t)-06-(*)-VTU12	Prefix-06-(*)-VTD12	12 ¹³ / ₁₆	25 ⁷ / ₈	13 ¹³ / ₁₆	27 ⁷ / ₈	15 ¹ / ₂	30 ³ / ₁₆
	12	09	Prefix(t)-09-(*)-VTU12	Prefix-09-(*)-VTD12	12 ¹³ / ₁₆	25 ⁷ / ₈	13 ¹³ / ₁₆	27 ⁷ / ₈	15 ¹ / ₂	30 ³ / ₁₆
	12	12	Prefix(t)-12-(*)-VTU12	Prefix-12-(*)-VTD12	12 ¹³ / ₁₆	25 ⁷ / ₈	13 ¹³ / ₁₆	27 ⁷ / ₈	15 ¹ / ₂	30 ³ / ₁₆
	12	18	Prefix(t)-18-(*)-VTU12	Prefix-18-(*)-VTD12	12 ¹³ / ₁₆	25 ⁷ / ₈	13 ¹³ / ₁₆	27 ⁷ / ₈	15 ¹ / ₂	30 ³ / ₁₆
	12	24	Prefix(t)-24-(*)-VTU12	Prefix-24-(*)-VTD12	12 ¹³ / ₁₆	25 ⁷ / ₈	13 ¹³ / ₁₆	27 ⁷ / ₈	15 ¹ / ₂	30 ³ / ₁₆
	12	30	Prefix(t)-30-(*)-VTU12	Prefix-30-(*)-VTD12	12 ¹³ / ₁₆	25 ⁷ / ₈	13 ¹³ / ₁₆	27 ⁷ / ₈	15 ¹ / ₂	30 ³ / ₁₆
	12	36	Prefix(t)-36-(*)-VTU12	Prefix-36-(*)-VTD12	12 ¹³ / ₁₆	25 ⁷ / ₈	13 ¹³ / ₁₆	27 ⁷ / ₈	15 ¹ / ₂	30 ³ / ₁₆
Down 	24	06	Prefix(t)-06-(*)-VTU24	Prefix-06-(*)-VTD24	24 ¹⁵ / ₁₆	49 ⁷ / ₈	25 ¹³ / ₁₆	51 ⁷ / ₈	27 ⁷ / ₈	54 ³ / ₁₆
	24	09	Prefix(t)-12-(*)-VTU24	Prefix-09-(*)-VTD24	24 ¹⁵ / ₁₆	49 ⁷ / ₈	25 ¹³ / ₁₆	51 ⁷ / ₈	27 ⁷ / ₈	54 ³ / ₁₆
	24	12	Prefix(t)-12-(*)-VTU24	Prefix-12-(*)-VTD24	24 ¹⁵ / ₁₆	49 ⁷ / ₈	25 ¹³ / ₁₆	51 ⁷ / ₈	27 ⁷ / ₈	54 ³ / ₁₆
	24	18	Prefix(t)-18-(*)-VTU24	Prefix-18-(*)-VTD24	24 ¹⁵ / ₁₆	49 ⁷ / ₈	25 ¹³ / ₁₆	51 ⁷ / ₈	27 ⁷ / ₈	54 ³ / ₁₆
	24	24	Prefix(t)-24-(*)-VTU24	Prefix-24-(*)-VTD24	24 ¹⁵ / ₁₆	49 ⁷ / ₈	25 ¹³ / ₁₆	51 ⁷ / ₈	27 ⁷ / ₈	54 ³ / ₁₆
	24	30	Prefix(t)-30-(*)-VTU24	Prefix-30-(*)-VTD24	24 ¹⁵ / ₁₆	49 ⁷ / ₈	25 ¹³ / ₁₆	51 ⁷ / ₈	27 ⁷ / ₈	54 ³ / ₁₆
	24	36	Prefix(t)-36-(*)-VTU24	Prefix-36-(*)-VTD24	24 ¹⁵ / ₁₆	49 ⁷ / ₈	25 ¹³ / ₁₆	51 ⁷ / ₈	27 ⁷ / ₈	54 ³ / ₁₆
Solid 	36	06	Prefix(t)-06-(*)-VTU36	Prefix-06-(*)-VTD36	36 ¹⁵ / ₁₆	73 ⁷ / ₈	37 ¹³ / ₁₆	75 ⁷ / ₈	39 ¹ / ₂	78 ³ / ₁₆
	36	09	Prefix(t)-09-(*)-VTU36	Prefix-09-(*)-VTD36	36 ¹⁵ / ₁₆	73 ⁷ / ₈	37 ¹³ / ₁₆	75 ⁷ / ₈	39 ¹ / ₂	78 ³ / ₁₆
	36	12	Prefix(t)-12-(*)-VTU36	Prefix-12-(*)-VTD36	36 ¹⁵ / ₁₆	73 ⁷ / ₈	37 ¹³ / ₁₆	75 ⁷ / ₈	39 ¹ / ₂	78 ³ / ₁₆
	36	18	Prefix(t)-18-(*)-VTU36	Prefix-18-(*)-VTD36	36 ¹⁵ / ₁₆	73 ⁷ / ₈	37 ¹³ / ₁₆	75 ⁷ / ₈	39 ¹ / ₂	78 ³ / ₁₆
	36	24	Prefix(t)-24-(*)-VTU36	Prefix-24-(*)-VTD36	36 ¹⁵ / ₁₆	73 ⁷ / ₈	37 ¹³ / ₁₆	75 ⁷ / ₈	39 ¹ / ₂	78 ³ / ₁₆
	36	30	Prefix(t)-30-(*)-VTU36	Prefix-30-(*)-VTD36	36 ¹⁵ / ₁₆	73 ⁷ / ₈	37 ¹³ / ₁₆	75 ⁷ / ₈	39 ¹ / ₂	78 ³ / ₁₆
	36	36	Prefix(t)-36-(*)-VTU36	Prefix-36-(*)-VTD36	36 ¹⁵ / ₁₆	73 ⁷ / ₈	37 ¹³ / ₁₆	75 ⁷ / ₈	39 ¹ / ₂	78 ³ / ₁₆
Up 										

(t) Insert side rail height. (*) Insert bottom style to complete cat. no. Includes 2 pairs of splice plates with hardware.

Selection guide

- Prefix: ALUF (aluminum), SPUF (pregalv.), SHUF (hot-dip galv.), SSUF (stainless steel)
- Inside tray widths: 06, 09, 12, 18, 24, 30, 36 in.
- Nominal radius: 12, 24, 36 in.
- Bottom styles: V– ventilated, S– solid
- Side rail height: 2, 3, 6 in.

Part numbering system

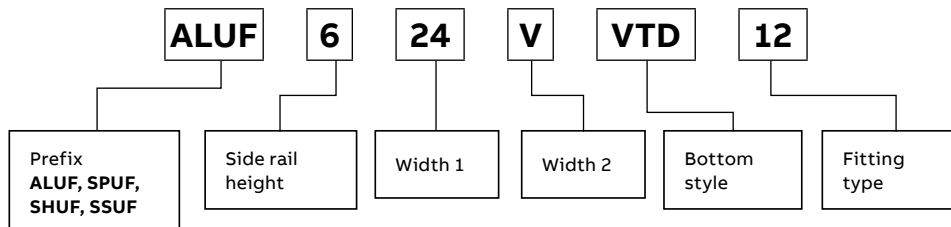

One-piece tray

Cable support fittings

Cable support

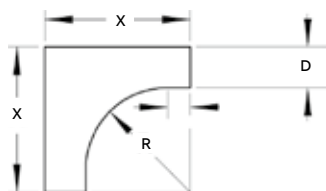

Nominal radius (in.)	Nominal width (in.)	Cat. no.	Side rail height "D"		
			2 in.	3 in.	6 in.
12	06	Prefix(t)-06-(*)-CS12	13 ⁷ / ₁₆	15 ⁵ / ₁₆	18 ³ / ₁₆
12	09	Prefix(t)-09-(*)-CS12	13 ⁷ / ₁₆	15 ⁵ / ₁₆	18 ³ / ₁₆
12	12	Prefix(t)-12-(*)-CS12	13 ⁷ / ₁₆	15 ⁵ / ₁₆	18 ³ / ₁₆
12	18	Prefix(t)-18-(*)-CS12	13 ⁷ / ₁₆	15 ⁵ / ₁₆	18 ³ / ₁₆
12	24	Prefix(t)-24-(*)-CS12	13 ⁷ / ₁₆	15 ⁵ / ₁₆	18 ³ / ₁₆
12	30	Prefix(t)-30-(*)-CS12	13 ⁷ / ₁₆	15 ⁵ / ₁₆	18 ³ / ₁₆
12	36	Prefix(t)-36-(*)-CS12	13 ⁷ / ₁₆	15 ⁵ / ₁₆	18 ³ / ₁₆
24	06	Prefix(t)-06-(*)-CS24	25 ⁷ / ₁₆	27 ⁷ / ₁₆	30 ³ / ₁₆
24	09	Prefix(t)-09-(*)-CS24	25 ⁷ / ₁₆	27 ⁷ / ₁₆	30 ³ / ₁₆
24	12	Prefix(t)-12-(*)-CS24	25 ⁷ / ₁₆	27 ⁷ / ₁₆	30 ³ / ₁₆
24	18	Prefix(t)-18-(*)-CS24	25 ⁷ / ₁₆	27 ⁷ / ₁₆	30 ³ / ₁₆
24	24	Prefix(t)-24-(*)-CS24	25 ⁷ / ₁₆	27 ⁷ / ₁₆	30 ³ / ₁₆
24	30	Prefix(t)-30-(*)-CS24	25 ⁷ / ₁₆	27 ⁷ / ₁₆	30 ³ / ₁₆
24	36	Prefix(t)-36-(*)-CS24	25 ⁷ / ₁₆	27 ⁷ / ₁₆	30 ³ / ₁₆
36	06	Prefix(t)-06-(*)-CS36	37 ⁷ / ₁₆	39 ⁵ / ₁₆	42 ³ / ₁₆
36	09	Prefix(t)-09-(*)-CS36	37 ⁷ / ₁₆	39 ⁵ / ₁₆	42 ³ / ₁₆
36	12	Prefix(t)-12-(*)-CS36	37 ⁷ / ₁₆	39 ⁵ / ₁₆	42 ³ / ₁₆
36	18	Prefix(t)-18-(*)-CS36	37 ⁷ / ₁₆	39 ⁵ / ₁₆	42 ³ / ₁₆
36	24	Prefix(t)-24-(*)-CS36	37 ⁷ / ₁₆	39 ⁵ / ₁₆	42 ³ / ₁₆
36	30	Prefix(t)-30-(*)-CS36	37 ⁷ / ₁₆	39 ⁵ / ₁₆	42 ³ / ₁₆
36	36	Prefix(t)-36-(*)-CS36	37 ⁷ / ₁₆	39 ⁵ / ₁₆	42 ³ / ₁₆

(t) Insert side rail height. (*) Insert bottom style to complete cat. no. Includes 1 pair of splice plates with hardware.

Selection guide

- Prefix: ALUF (aluminum), SPUF (pregalv.), SHUF (hot-dip galv.), SSUF (stainless steel)
- Inside tray widths: 06, 09, 12, 18, 24, 30, 36 in.
- Nominal radius: 12, 24, 36 in.
- Bottom styles: V– ventilated, S– solid
- Side rail height: 2, 3, 6 in.

Part numbering system

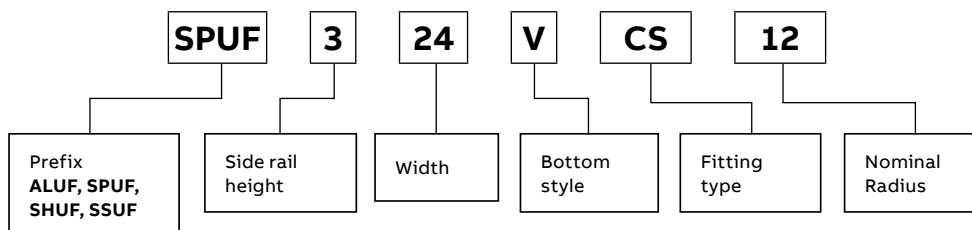

One-piece tray covers

Straight and fitting covers

Straight cover number selection

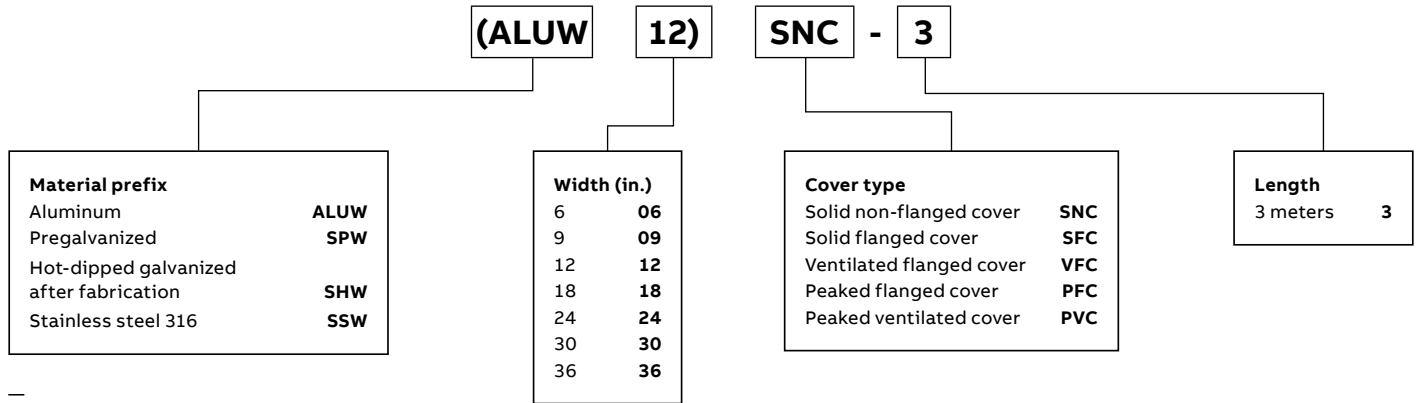

* For SHW covers, maximum lengths are 72 in. and 1500 mm.

Fitting cover number selection

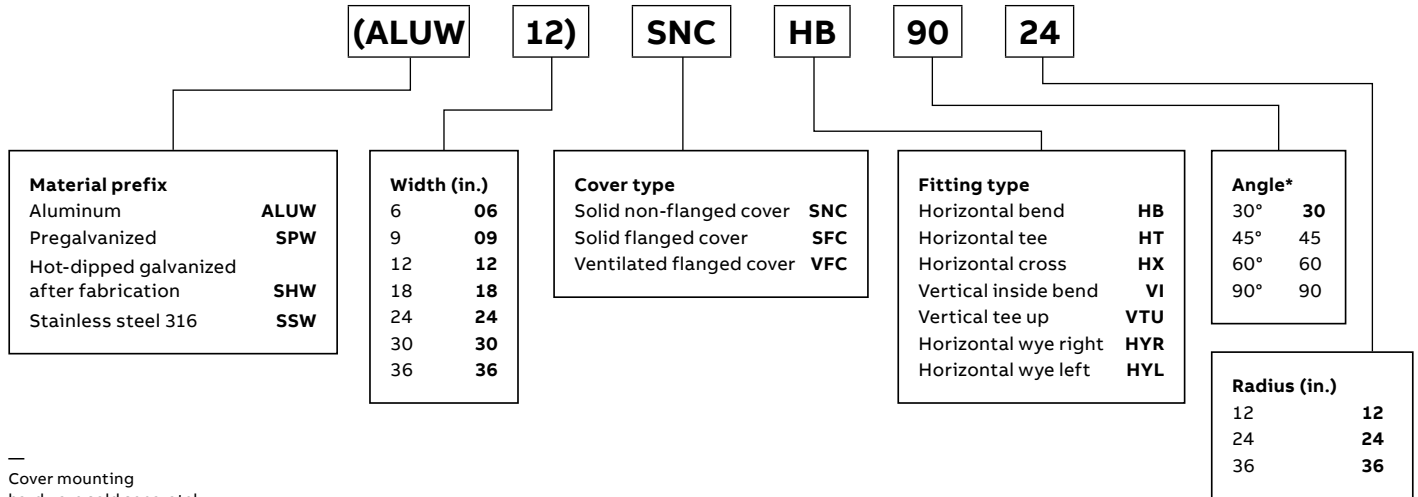

— Cover mounting hardware sold separately.
 * Required for HB and VI only.

One-piece tray covers

Fitting covers

Fitting cover number selection (continued)

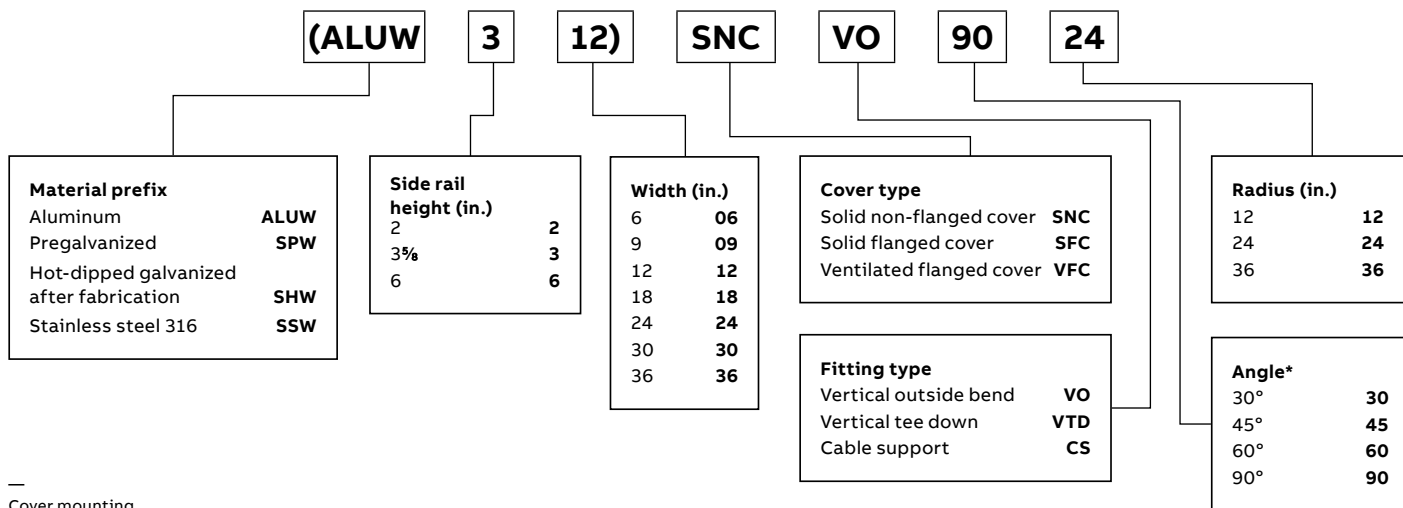
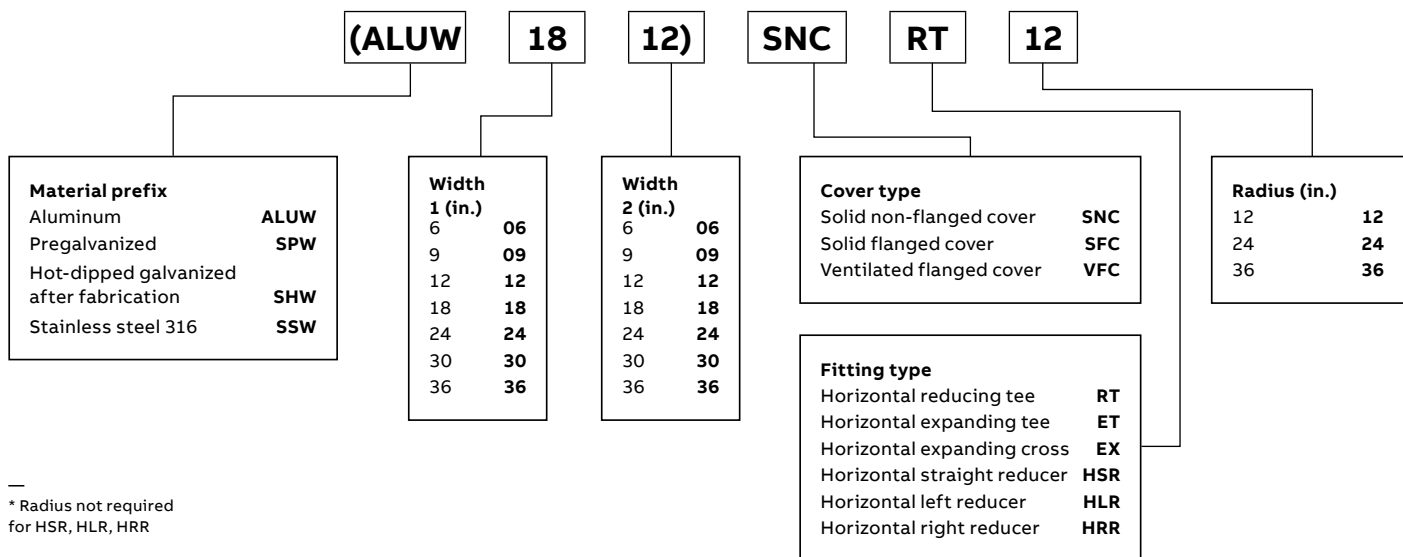

One-piece tray covers

Accessories for covers

Hold-down clamp

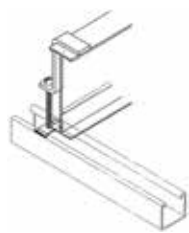
		Cat. no.	Material prefix	Side rail height (in.)
 		(Prefix)-2-HDC	SPUW, SSUW, SHUW	2
		(Prefix)-3-HDC	SPUW, SSUW, SHUW	3
		(Prefix)-6-HDC	SPUW, SSUW, SHUW	6

Designed to secure cable tray to support system.

Cover clamp

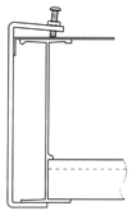
		Cat. no.	Material prefix	Side rail height (in.)
 		(Prefix)-2-SCC	SPUW, SSUW	2
		(Prefix)-3-SCC	SPW, SSW	3
		(Prefix)-6-SCC	SPW, SSW	6

Rigid cover clamp for flat and flanged covers.

Selection guide

- Tray widths: 06, 09, 12, 18, 24, 30, 36 in.

Heavy-duty cover clamp

		Cat. no.	Material prefix	Side rail height (in.)	Tray width (in.)
		(Prefix)-2-**-HCC	ALUW, SPUW, SSUW, SHUW	2	06 to 36
		(Prefix)-3-**-HCC	ALUW, SPW, SHW, SSW	3	06 to 36
		(Prefix)-6-**-HCC	ALUW, SPW, SHW, SSW	6	06 to 36

One-piece tray splice plates

Standard, expansion splice plate and reducing splice



Standard splice plate

- Packaged in pairs with hardware
- Kit contents: 8 bolts, 8 serrated flange nuts 3/8 in. diameter
- Provided as standard with each straight and/or fitting

Cat. no.	Material prefix	Side rail height (in.)
(Prefix)-2-SSP	ALUW, SPUW, SSUW, SHUW	2
(Prefix)-3-SSP	ALUW, SPW, SSW, SHW	3
(Prefix)-6-SSP	ALUW, SPW, SSW, SHW	6



Expansion splice plate

- Allows for a 1 in. expansion or contraction of tray system
- Packaged in pairs with hardware
- Kit contents: 8 bolts, 4 stop nuts, 4 serrated flange nuts 3/8 in. diameter

Cat. no.	Material prefix	Side rail height (in.)
(Prefix)-2-ESP	ALUW, SPUW, SSUW, SHUW	2
(Prefix)-3-ESP	ALUW, SPW, SSW, SHW	3
(Prefix)-6-ESP	ALUW, SPW, SSW, SHW	6



Reducing splice

- Used in pairs to provide a straight reduction or used with a standard splice plate for an offset reduction
- One per package with hardware
- Kit contents: 4 bolts, 4 nuts

	Cat. no.	Material prefix	Side rail height (in.)
	(Prefix)-2(*)-RSP	ALUW, SPUW, SSUW, SHUW	2
	(Prefix)-3(*)-RSP	ALUW, SPW, SSW, SHW	3
	(Prefix)-6(*)-RSP	ALUW, SPW, SSW, SHW	6

*Note: For offset reduction: Insert width to be reduced. For straight reduction: Insert 1/2 width to be reduced (2 required)
 Example: ALUW-603-RSP = 3 in. offset reducer

One-piece tray barrier strips

Horizontal and vertical barriers strips, barrier clamp and splice strips



Horizontal barrier strips

Cat. no.	Material prefix	Height (in.)	Length
(Prefix)-2-SB-3	ALUW, SPUW, SHUW*, SSUW	2	3 m
(Prefix)-3-SB-3	ALUW, SPUW, SHUW*, SSUW	3	3 m
(Prefix)-6-SB-3	ALUW, SPUW, SHUW*, SSUW	6	3 m
(Prefix)-2-SBH-72	ALUW, SPUW, SHUW*, SSUW	2	72 in.
(Prefix)-3-SBH-72	ALUW, SPUW, SHUW*, SSUW	3	72 in.
(Prefix)-6-SBH-72	ALUW, SPUW, SHUW*, SSUW	6	72 in.

NOTE: 72 in. barriers provided with 3 SPW10SCR, 3 m barriers provided with 6 SPW10SCR

*Available in 1500 mm only.

- Barrier strips provide a method of separating cables in tray and trough systems
- Easily installed using supplied hardware or barrier strip clamps (sold separately)
- 72 in. barriers are flexible for use with horizontal fittings



Vertical barriers strips

Inside bend cat. no.	Outside bend cat. no.	Material prefix	Height (in.)	Angle (°)	Radius (in.)
(Prefix)-2-VIB-(*)-(**)	Prefix-2-VOB-(*)-(**)	ALUW, SPUW, SHUW†, SSUW	2 to 6	30 to 90	12 to 36
(Prefix)-3-VIB-(*)-(**)	Prefix-3-VOB-(*)-(**)	ALUW, SPUW, SHUW†, SSUW	2 to 6	30 to 90	12 to 36
(Prefix)-6-VIB-(*)-(**)	Prefix-6-VOB-(*)-(**)	ALUW, SPUW, SHUW†, SSUW	2 to 6	30 to 90	12 to 36
		ALUW, SPUW, SHUW†, SSUW	2 to 6	30 to 90	12 to 36

(*) Insert angle (**) Insert radius. †Available in 1500 mm only.

- Preformed to fit all standard steel vertical bends.
- Provided with hardware
- Height 2, 3, 6 in.
- Angle 30, 45, 60, 90°
- Radius 12, 24, 36 in.

Barrier strip clamp



Cat. no.	Material
SPW-BSC	Zinc-plated steel
SSW-BSC	Stainless steel 316

- Barrier strip clamps mount barrier strips to ladder rungs and ventilated bottoms
- Complete mounting hardware supplied

Barrier strip splice



Cat. no.	Material prefix
ABW-BSS	SPW
	SPW

Alignment splice for joining connecting barrier strips.

One-piece tray accessories

Closure end plate and drop out

Closure end plate

• Tray width: 06, 09, 12, 18, 24, 30, 36 in.

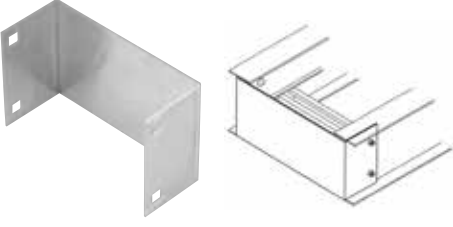
	Cat. no.	Material prefix	Side rail height (in.)	Tray width (in.)
	(Prefix)-2-**-CEP	ALUW, SPUW, SHUW, SSUW	2	06 to 36
	(Prefix)-3-**-CEP	ALUW, SPW, SSW, SHW	3	06 or 36
	(Prefix)-6-**-CEP	ALUW, SPW, SSW, SHW	6	06 or 36

Provides closure for any tray end. Hardware included.

** Insert tray width

- Designed to provide a smooth radius surface at any position on the tray or trough bottom
- Drop outs are easily attached using hardware provided
- Standard radius = 4 in.
- Width : 06, 09, 12, 18, 24, 30, 36 in.

Drop out

	Cat. no.	Material prefix	Width (in.)
	(Prefix)-**-DOS	ALUW, SPW, SHW, SSW	06 to 36

** Insert tray width

One-piece tray accessories

Steel tray hardware, horizontal and vertical adjustable plates

Steel tray hardware

	Cat. no.	Material	Description
	SPW-1/4-CB	Zinc-plated steel	¼ in. carriage bolt
	SPW-3/8-CB	Zinc-plated steel	¾ in. carriage bolt
	SPW-1/4-HN	Zinc-plated steel	¼ in. serrated flange nuts
	SPW-3/8-HN	Zinc-plated steel	¾ in. serrated flange nuts
	SSW-3/8-CB	316 stainless	¾ in. carriage bolt
	SSW-3/8-HN	316 stainless	¾ in. hex. nut
	SSW-3/8-HWK*	316 stainless	316 stainless steel hardware kit

Square shoulder self-positioning carriage bolt.

* Hardware kit: Contains 8 serrated flange nuts, 8 bolts.

- Adjustable hinge plates provide maximum horizontal installation flexibility.
- Furnished as a kit with hardware.
- Tray widths : 06, 09, 12, 18, 24, 30, 36 in.

Flexible coupler

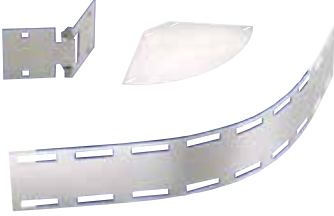
	Cat. no.	Material prefix	Side rail height (in.)	Tray width (in.)
	(Prefix)-(*)(**)-HAP	ALUW, SPUW, SSUW, SHUW	2, 3, 6	06 to 36

(*) Insert side rail height

(**) Insert tray width

- Adjustable hinge plates provide maximum horizontal installation flexibility for elevation changes
- Furnished as a kit with hardware
- Tray widths : 06, 09, 12, 18, 24, 30, 36 in.

Vertical adjustable plate

	Cat. no.	Material prefix	Side rail height (in.)	Tray width (in.)
	(Prefix)-*-*-VSP	ALUW, SPUW, SSUW, SHUW	2, 3, 6	06 to 36

*Insert side rail height

**Insert width

One-piece tray covers accessories

Horizontal tee branch and box-to-tray plates

- Designed to secure tray to electrical panels or boxes, walls or end supports
- Packaged in pairs with hardware
- Tray widths : 06, 09, 12, 18, 24, 30, 36 in.

Horizontal tee branch



Cat. no.	Material prefix	Side rail height (in.)	Tray width (in.)
(Prefix)-(*)-(**)-HTB	ALUW, SPUW, SSUW, SHUW	2, 3, 6	06 to 36

(*) Insert side rail height
 (**) Insert width



- Designed to secure tray to electrical panels or boxes, walls or end supports
- Packaged in pairs with hardware

Box-to-tray plates

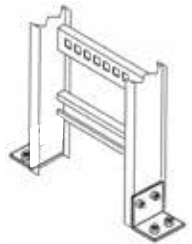

Cat. no.	Material prefix	Side rail height (in.)
(Prefix)-2-BSP	ALUW, SPUW, SSUW, SHUW	2
(Prefix)-3-BSP	ALUW, SPW, SSW, SHW	3
(Prefix)-6-BSP	ALUW, SPW, SSW, SHW	6