

## Pole line hardware

### Heavy-duty spool rack (200 A)



Cat. no.	No. of wires	Overall length (in.)	Weight (100 pcs)		Std. pkg.
			lb	kg	
SS401E	1	9½	300	136.3	10
SS802E	2	17½	520	236.3	5
SS803E	3	25½	780	354.5	5
SS804E	4	33½	1,040	472.7	5

Racks are made of 1 in. x 1 in. x ¼ in. angle iron, assembled complete with ⅝ in. diameter rod and ⅜ in. diameter brass cotter pin. All ferrous parts are hot dip galvanized. Insulator cat. no. IB135 must be ordered separately (included in SS401E only).

### Heavy-duty spool rack (400 A)



Cat. no.	No. of wires	Overall length (in.)	Weight (100 pcs)		Std. pkg.
			lb	kg	
MM801	1	3	360	163.2	10

Fits 3½ in. and 4 in. rigid conduit.

### Medium-duty spool rack (100 A)



Cat. no.	No. of wires	Overall dia. (in.)	Weight (100 pcs)		Std. pkg.
			lb	kg	
SS18	1	6½	150	68.1	25

Medium-duty spool rack is furnished complete with cat. no. IB134 insulator. All ferrous parts are hot dip galvanized.

## Pole line hardware

### Tripods (200 A)

Cat. no.	No. of wires	Weight (100 pcs)		Std. pkg.
		lb	kg	
603TH*	3	4,000	1818.1	1

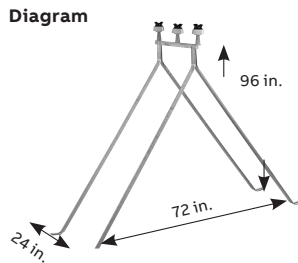

Type "T" (medium duty) is constructed of 1 in. x 1 in. x 1/8 in. angle iron. Type "TH" (heavy duty) is constructed of 1 1/4 in. x 1 1/4 in. x 3/16 in. angle iron. All ferrous parts are hot dip galvanized. \* Complete with IB400.

### Tripod insulator (200 A)

Cat. no.	Height (in.)	Overall dia. (in.)	Weight (100 pcs)		Std. pkg.
			lb	kg	
IB400	3 1/2	3 1/4	125	56.8	25



### Insulators (100-400 A)

Cat. no.	Ampere	Height (in.)	Diameter (in.)	Hole dia. (in.)	Weight (100 pcs)		Std. pkg.
					lb	kg	
IB134	100	2	2 1/4	9/16	40	18.1	100
IB135	200 and 400	3	3	13/16	115	52.2	50



Porcelain insulator securely held in the hot galvanized steel clevis by a cotter pin.

### Screw type insulator (100 A)

Cat. no.	Insulator length (in.)	Pull out strength	Weight (100 pcs)		Std. pkg.
			lb	kg	
IB900	3	1,500 lb	87	39.5	25

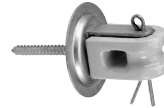

Porcelain insulator securely held in the hot galvanized steel clevis by a cotter pin.

### Light-duty clevis (100 A)

Cat. no.	Mounting hole	Weight (100 pcs)		Std. pkg.
		lb	kg	
AN422	1 1/16 in. Round	90	40.9	25
AN422KIT	1 1/16 in. Round with bolts and washers	-	-	1
AN423	9/16 in. x 9/16 in. square	90	40.9	25



Diagram

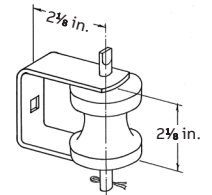

Add suffix "NI" if insulator is not required. Constructed of 3/8 in. x 1 in. flat mild steel, has 3/8 in. diam. pin and C/W No. IB134 insulator, mounting hole as per table above. All ferrous parts are hot dip galvanized.

### Clevis (200 A)

Cat. no.	Weight (100 pcs)		Std. pkg.
	lb	kg	
AN424	100	45.4	25



Diagram

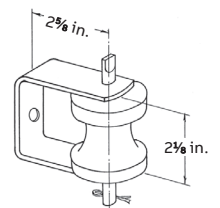

Add suffix "NI" if insulator is not required. Constructed of 3/8 in. x 1 1/4 in. flat mild steel, has 3/8 in. diam. pin and complete with catalog no. IB134 insulator, 3/8 in. round mounting hole. All ferrous parts are hot dip galvanized.

## Pole line hardware

### Heavy-duty clevis (200 A)

Cat. no.	Weight (100 pcs)		Std. pkg.
	lb	kg	
AN428S	262	119	25

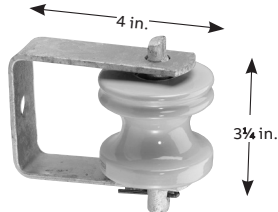

Add suffix "NI" if insulator is not required. Constructed of  $\frac{3}{16}$  in. x  $1\frac{1}{2}$  in. flat mild steel, has  $\frac{5}{8}$  in. diam. pin and complete with catalog no. IB135 insulator,  $\frac{3}{16}$  in. round mounting hole. All ferrous parts are hot dip galvanized.

### Heavy-duty clevis (200 A)

Cat. no.	Weight (100 pcs)		Std. pkg.
	lb	kg	
AN428	350	159	5

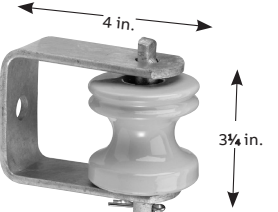

Add suffix "NI" if insulator is not required. Constructed of  $\frac{1}{4}$  in. x 2 in. flat mild steel, has  $\frac{5}{8}$  in. diam. pin and complete with catalog no. IB135 insulator,  $\frac{3}{16}$  in. round mounting hole. All ferrous parts are hot dip galvanized.

### Heavy-duty flat mount triplex cable rack (200 A)

Cat. no.	Weight (100 pcs)		Std. pkg.
	lb	kg	
AN117	290	130	10

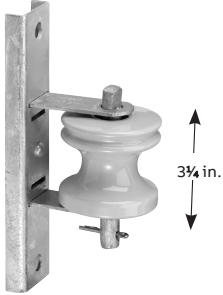

Heavy-duty wall rack constructed of  $\frac{1}{2}$  in. steel, with 2 mounting holes  $\frac{1}{2}$  in., complete with catalog no. IB135 insulator. All ferrous parts are hot dip galvanized.

### Light-duty flat mount triplex cable rack (100 A)

Cat. no.	Weight (100 pcs)		Std. pkg.
	lb	kg	
AN122	160	70	10

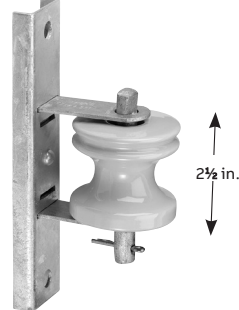

Light-duty wall rack constructed of  $\frac{1}{8}$  in. steel, with 2 mounting holes  $\frac{1}{2}$  in., complete with catalog no. IB134 insulator. All ferrous parts are hot dip galvanized.

## Pole line hardware

### Clevis (100 A)

Cat. no.	Weight (100 pcs)		Std. pkg.
	lb	kg	
AL425	162	73.6	20

Add suffix "NI" if insulator is not required. Constructed of  $\frac{3}{16}$  in. x  $1\frac{1}{2}$  in. flat mild steel, has  $\frac{1}{2}$  in. diam. pin and comes with catalog no. IB134 insulator,  $\frac{3}{16}$  in. round mounting hole. All ferrous parts are hot dip galvanized.

### Clevis (200 A)

Cat. no.	Weight (100 pcs)		Std. pkg.
	lb	kg	
AU427	265	120.4	10

Add suffix "NI" if insulator is not required. Constructed of  $1\frac{1}{4}$  in. x  $\frac{1}{2}$  in. x  $\frac{1}{8}$  in. steel channel, has  $\frac{5}{8}$  in. diam. pin and comes with catalog no. IB135 insulator,  $\frac{3}{16}$  in. round mounting hole. All ferrous parts are hot dip galvanized.

### Clevis (200 A)

Cat. no.	Weight (100 pcs)		Std. pkg.
	lb	kg	
AL426	262	119	10

Add suffix "NI" if insulator is not required. Constructed of  $\frac{3}{16}$  in. x  $1\frac{1}{2}$  in. flat mild steel, has  $\frac{5}{8}$  in. diam. pin and comes with catalog no. IB135 insulator,  $\frac{3}{16}$  in. round mounting hole. All ferrous parts are hot dip galvanized.

### Clevis (200 A)

Cat. no.	Weight (100 pcs)		Std. pkg.
	lb	kg	
AU429	240	109	10

Add suffix "NI" if insulator is not required. Constructed of 1 in. x  $\frac{1}{2}$  in. x  $\frac{1}{8}$  in. steel channel, has  $\frac{5}{8}$  in. diam. pin comes with catalog no. IB135 insulator,  $\frac{3}{16}$  in. square hole. All ferrous parts are hot dip galvanized.

## Pole line hardware

Clevis (100 A)

Cat. no.	Weight (100 pcs)		Std. pkg.
	lb	kg	
SW409	100	45.4	25



Add suffix "NI" if insulator is not required. Constructed of 3/8 in. x 1 in. curved mild steel, has 3/8 in. diam. swivel type pin, comes with catalog no. IB134 insulator, 2 mtg. holes 7/16 in. round. All ferrous parts are hot dip galvanized.

Clevis (100 A)

Cat. no.	Weight (100 pcs)		Std. pkg.
	lb	kg	
SW411	125	56.8	20

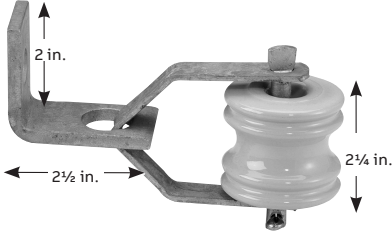

Add suffix "NI" if insulator is not required. Constructed of 1/8 in. x 3/4 in. curved mild steel, has 3/8 in. diam. swivel type pin, comes with catalog no. IB134 insulator, strong 1/4 in. angle bracket, 1 1/16 in. round mtg. hole. All ferrous parts are hot dip galvanized.

Clevis (100 A)

Cat. no.	Weight (100 pcs)		Std. pkg.
	lb	kg	
SW410	180	81.8	20

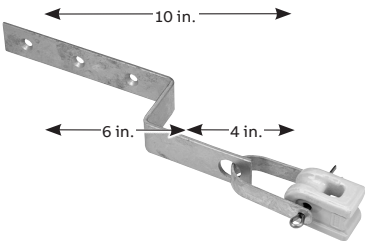

Add suffix "NI" if insulator is not required. Undereave/off the wall bracket constructed of 3/16 in. x 1 1/2 in. flat mild steel, comes with catalog no. IB132 insulator. Three 3/8 in. round mtg. holes. All ferrous parts are hot dip galvanized.

Clevis (100 A)

Cat. no.	Weight (100 pcs)		Std. pkg.
	lb	kg	
SW411S	125	56.8	20

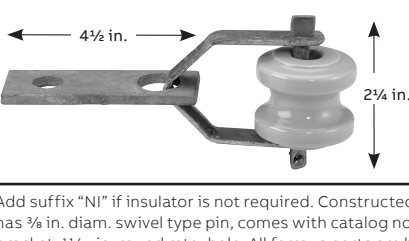

Add suffix "NI" if insulator is not required. Constructed of 1/8 in. x 3/4 in. curved mild steel, has 3/8 in. diam. swivel type pin, comes with catalog no. IB134 insulator, strong 1/4 in. bracket, 1 1/16 in. round mtg. hole. All ferrous parts are hot dip galvanized.

## Pole line hardware

### Clevis (100 A)

Cat. no.	Weight (100 pcs)		Std. pkg.
	lb	kg	
SW412	100	45.4	10



Add suffix "NI" if insulator is not required. Constructed of 3/16 in. x 1 1/2 in. steel, comes with catalog no. IB134 insulator. Three 3/8 in. round mtg. holes. All ferrous parts are hot dip galvanized.

### Clevis (100 A)

Cat. no.	Weight (100 pcs)		Std. pkg.
	lb	kg	
SW412-MH	140	63.5	20



Add suffix "NI" if insulator is not required. Constructed of 3/16 in. x 1 1/2 in. steel, has 3/8 in. diam. pin and comes with catalog no. IB134 insulator. 1 1/8 in. round mtg. hole. All ferrous parts are hot dip galvanized.

### Anti-vibration kit for spool rack

Cat. no.	Description	Weight (100 pcs)		Std. pkg.
		lb	kg	
B3/8-6	2 bolts 3/8 x 6 in. long, complete with 1 washer, 1 lockwasher and 1 nut finished hot galv.	100	45.35	5



Add suffix "NI" if insulator is not required. Constructed of 1 1/4 in. x 1/2 in. x 3/8 in. steel channel, has 3/8 in. diam. pin and comes with catalog no. IB135 insulator, 1 1/8 in. round mounting hole. All ferrous parts are hot dip galvanized.

Québec Construction Code, Chapter V – Electricity, Article 6-112 (6) requires that the spool rack be tightly bolted and attached to structural members of a minimum thickness of 88 mm overall, if the framed structure is made of wood.

Hydro-Québec, Low-Voltage Electrical Service, Standard E21-10, Article 2.2.1, 2.2.2 and Blue Book read as follows:

#### 2.2.1 Supply and installation

The master electrician shall, at the customer's expense, supply and install the spool rack in accordance with Code requirements and with the recommendations of the Régie du bâtiment du Québec, particularly to avoid any problem due to vibrations. The customer retains ownership of the spool rack.

#### 2.2.2 Location

The spool rack may be attached to the exterior wall of a building or to a customer pole, service mast or other support structure. The master electrician shall ensure that the service loop is secured firmly to the building in a location not conducive to vibrations, and shall strengthen the structure, if necessary, at the customer's expense. The location must also allow the meter to be installed in a readily accessible place.

### Diagrams

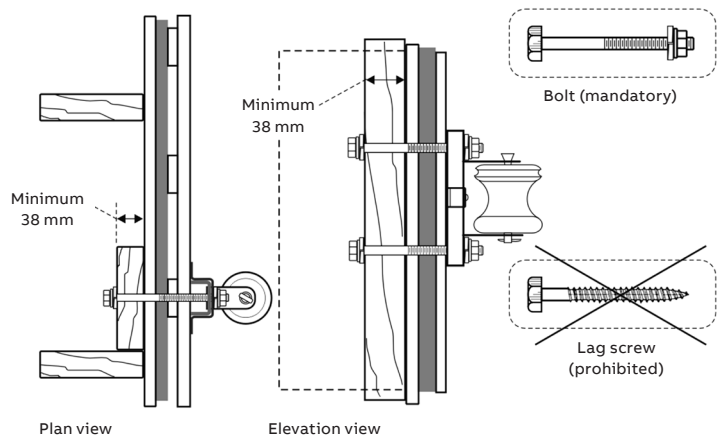

Note: Interior insulation and exterior wall are not shown for more clarity. Figure 2: Spool rack installation (wooden structure). Source: Régie du bâtiment du Québec. Can also be used in all provinces.

## Pole line hardware

### Machine bolts

Cat. no.	F diam. (in.)	G long. (in.)	H min. (in.)	Weight (100 pcs)		Std. pkg.
				lb	kg	
BM506	$\frac{5}{8}$	6	1½	70	31.8	50
BM508	$\frac{5}{8}$	8	4	86	39.0	50
BM510	$\frac{5}{8}$	10	4	102	46.3	25
BM512	$\frac{5}{8}$	12	6	115	52.2	25
BM514	$\frac{5}{8}$	14	6	130	59.0	30
BM516	$\frac{5}{8}$	16	6	145	65.9	30
BM518	$\frac{5}{8}$	18	6	160	72.7	25
BM520	$\frac{5}{8}$	20	6	175	79.5	30



Diagrams

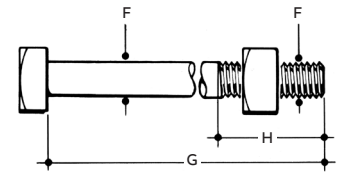

### Lag screws

Cat. no.	F diam. (in.)	G long. (in.)	Weight (100 pcs)		Std. pkg.
			lb	kg	
T102L	$\frac{1}{4}$	2½	3	1.3	100
T103	$\frac{1}{4}$	3	4	1.8	100
T203	$\frac{5}{16}$	3	6	2.7	100
T302	$\frac{3}{8}$	2	7	3.1	100
T303	$\frac{3}{8}$	3	10	4.5	100
T304	$\frac{3}{8}$	4	11	5.0	50
T305	$\frac{3}{8}$	5	14	6.3	25
T306	$\frac{3}{8}$	6	17	7.7	50
T308	$\frac{3}{8}$	8	22	10.0	50
T310	$\frac{3}{8}$	10	27	12.2	10
T404-CM	$\frac{1}{2}$	4	22	10.0	50
T405	$\frac{1}{2}$	5	27	12.2	25
T406	$\frac{1}{2}$	6	31	14.0	25
T505	$\frac{5}{8}$	5	45	20.4	25



## Pole line hardware

### “U” cable guards and straps

Cat. no.	Width (in.)	Length (ft.)	Size (in.)	Weight (100 pcs)		Std. pkg.
				lb	kg	
<b>Straight</b>						
UG8114	1¼	8	–	760	345	5
UG8214	2¼	8	–	1,300	590	5
UG8314	3¼	8	–	2,000	909	5
<b>Flared</b>						
UGF8114	1¼	8	–	760	345	5
UGF8214	2¼	8	–	1,300	590	5
UGF8314	3¼	8	–	2,000	909	5
<b>Strap</b>						
SUG114	–	–	1¼	15	6.8	10
SUG214	–	–	2¼	24	11.0	10
SUG314	–	–	3¼	60	27.0	10

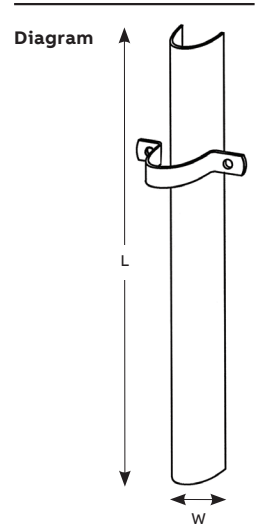

Hot dip galvanized 14 gauge steel. For nonmetallic version (PV-Mold), refer to page D90.

### Guy clamps

Cat. no.	Qty.	Bolt size (in.)	Length (in.)	Range (in.)	Weight (100 pcs)		Std. pkg.
					lb	kg	
GC902	2	½	3¼	¼–7/16	130	59.0	50
GC904	3	½	57/8	¼–7/16	224	101.3	25
GC906	3	5/8	6	5/16–½	274	124.5	25

### Eye nut

Cat. no.	Eye dimensions (in.)	Weight (100 pcs)		Std. pkg.
		lb	kg	
K58	1½/16 X 1¼/16	70	31.8	50

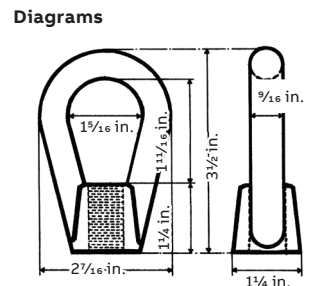

Drop forged, hot galvanized, tapped 5/8 in.



## Pole line hardware

### Guy hooks

	Cat. no.	Bolt size (in.)	Weight (100 pcs)		Std. pkg.
			lb	kg	
	CH912	$\frac{5}{8}$	90	40.9	50
	K133A	$\frac{5}{8}$ – $\frac{3}{4}$	118	53.6	25

CH912: Prevents the guy from slipping down when the pole is guyed at a sharp angle. Made of half oval steel, the round side serving as protection to the strands.  
K133A: Iron guy hook for use with  $\frac{5}{8}$  in. or  $\frac{3}{4}$  in. bolt. Equipped with teeth to imbed in the wood fibres.

### Screw anchor

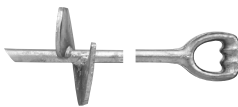
	Cat. no.	Rod dia. (in.)	Length (ft.)	Plate dia. (in.)	Weight (100 pcs)		Std. pkg.
					lb	kg	
	TS346	$\frac{3}{4}$	5.6	6	1,050	477.2	2

Installed by placing a rod into the heavy forged oval eye to screw the anchor into the ground.

### Anchor rods

	Cat. no.	Rod dia. (in.)	Length (ft.)	Type	Weight (100 pcs)		Std. pkg.
					lb	kg	
	AR586	$\frac{5}{8}$	6	Double thimble	750	340.9	5
	AR347	$\frac{3}{4}$	7	Double thimble	1,320	600.0	

### Expanding anchor

	Cat. no.	Hole size required (in.)	Area (sq. in.)	Rod dia. (in.)	Weight (100 pcs)		Std. pkg.
					lb	kg	
	EA08	8	135	$\frac{5}{8}$ – $\frac{3}{4}$	950	431.8	5
	ME-DA4PC2	8	16X16	$\frac{5}{8}$ – $\frac{3}{4}$	1165	528.5	5

These heavy-duty steel anchors have 8 blades that expand to form a square, with equalized load distribution all around the anchor.

## Pole line hardware

### Oval eye bolt

Cat. no.	Description	F dia. (in.)	G length (in.)	H min. (in.)	Weight (100 pcs)		Std. pkg.
					lb	kg	
BO506	Oval eye bolt	5/8	6	3	122	55.4	50
BO508	Oval eye bolt	5/8	8	4	136	61.8	25
BO510	Oval eye bolt	5/8	10	4	150	68.1	25
BO512	Oval eye bolt	5/8	12	4	168	76.3	25

Diagram

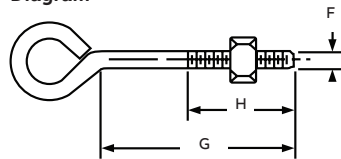

### Guy wire guard

Cat. no.	Colour	Length (ft.)	Weight (100 pcs)		Std. pkg.
			lb	kg	
2YG	Yellow	6.7	3.35	1.46	10



Diagrams

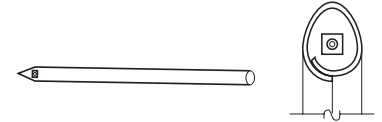

### Guy strain insulator

Cat. no.	Length (ft.)	Dia. (in.)	Weight (100 pcs)		Std. pkg.
			lb	kg	
504WGS	4 1/4	2 7/8	1.0	0.45	1
506WGS	5 1/2	3 3/8	1.0	0.45	1



Diagrams

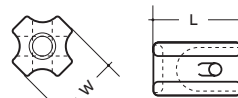

Note: Made of porcelain

### Type W – Aluminum service wedge clamps for use with ACSR, aluminum, AAAC conductors

- For dead-ending self-supporting drop wire
- Saves conductor – drop wire may be cut to exact length
- Can be attached to bare neutral at any point in the span
- Adjustments in drop wire sag are easily made
- Grips ACSR, AAAC or aluminum conductors

	Cat. no.	Conductor range (AWG)			Dimensions (in.)		Typical tensile values	
		ACSR	Al	AAAC	D	L	Conductor	Value (lb)
W-1 Series aluminum wedge and slider	W62-1	2-6	1 str. - 6 sol.	2-6	2 3/8 flex.	12, 17 1/2	2 6 x 1 ACSR	1,200
	W62-1FC	2-6	1 str. - 6 sol.	2-6	2 3/8 flex.	12, 17 1/2	2 6 x 1 ACSR	1,200
"FC" flexible bail (bail length - 11 1/2 in.)	W20-1	1/0-4	2/0 str. - 2 sol.	1/0-4	2 3/8 flex.	12 1/2, 18 1/2	1/0 6 x 1 ACSR	1,800
	W20-1FC	1/0-4	2/0 str. - 2 sol.	1/0-4	2 3/8 flex.	12 1/2, 18 1/2	1/0 6 x 1 ACSR	1,800
Rigid stainless steel bail (bail length - 6 1/2 in.)	W40-1*	4/0-2/0	4/0 str. - 2 sol.	4/0-2/0	2 3/8 flex.	12 3/4, 18 1/2	4/0 6 x 1 ACSR	1,900
	W40-1FC*	4/0-2/0	4/0 str. - 2 sol.	4/0-2/0	2 3/8 flex.	12 3/4, 18 1/2	4/0 6 x 1 ACSR	1,900

Diagram

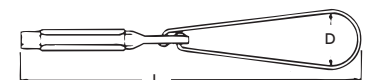

\* W40 series clamps rated 850 lb ultimate tension for 1/0 AWG ACSR, Al or AAAC.